

# AIR CONDITIONER

## Duct Type

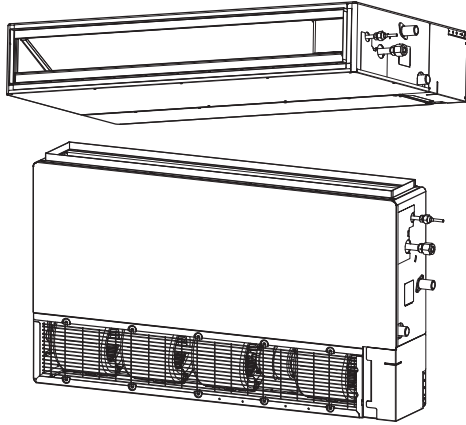

# INSTALLATION MANUAL



PART No. 9374342594-01

## 1. SAFETY PRECAUTIONS

### 1.1. IMPORTANT! Please read before starting

This air conditioning system meets strict safety and operating standards. As the installer or service person, it is an important part of your job to install or service the system so it operates safely and efficiently.

For safe installation and trouble-free operation, you must:

- Carefully read this instruction booklet before beginning.
- Follow each installation or repair step exactly as shown.
- Observe all local, state, and national electrical codes.
- Pay close attention to all danger, warning, and caution notices given in this manual.

**WARNING:** This symbol refers to a hazard or unsafe practice which can result in severe personal injury or death.

**CAUTION:** This symbol refers to a hazard or unsafe practice which can result in personal injury and the potential for product or property damage.

- Hazard alerting symbols



: Electrical



: Safety/alert

#### If Necessary, Get Help

These instructions are all you need for most installation sites and maintenance conditions. If you require help for a special problem, contact our sales/service outlet or your certified dealer for additional instructions.

#### In Case of Improper Installation

The manufacturer shall in no way be responsible for improper installation or maintenance service, including failure to follow the instructions in this document.

## 1.2. SPECIAL PRECAUTION

### When Wiring

**ELECTRICAL SHOCK CAN CAUSE SEVERE PERSONAL INJURY OR DEATH. ONLY A QUALIFIED, EXPERIENCED ELECTRICIAN SHOULD ATTEMPT TO WIRE THIS SYSTEM.**

- Do not supply power to the unit until all wiring and tubing are completed or reconnected and checked.
- Highly dangerous electrical voltages are used in this system. Carefully refer to the wiring diagram and these instructions when wiring. Improper connections and inadequate grounding (earthing) can cause accidental injury or death.
- Ground (Earth) the unit following local electrical codes.
- Connect all wiring tightly. Loose wiring may cause overheating at connection points and a possible fire hazard.

### When Transporting

Be careful when picking up and moving the indoor and outdoor units. Get a partner to help, and bend your knees when lifting to reduce strain on your back. Sharp edges or thin aluminum fins on the air conditioner can cut your fingers.

### When Installing...

#### ...In a Ceiling or Wall

Make sure the ceiling/wall is strong enough to hold the unit's weight. It may be necessary to construct a strong wood or metal frame to provide added support.

#### ...In a Room

Properly insulate any tubing run inside a room to prevent "sweating" that can cause dripping and water damage to walls and floors.

#### ...In an Area with High Winds

Securely anchor the outdoor unit down with bolts and a metal frame. Provide a suitable air baffle.

#### ...In a Snowy Area (for Heat Pump-type Systems)

Install the outdoor unit on a raised platform that is higher than drifting snow.

### When Connecting Refrigerant Tubing

- Keep all tubing runs as short as possible.
- Use the flare method for connecting tubing.
- Apply refrigerant lubricant to the matching surfaces of the flare and union tubes before connecting them, then tighten the nut with a torque wrench for a leak-free connection.
- Check carefully for leaks before opening the refrigerant valves.

For authorized service personnel only.

## Contents

1. SAFETY PRECAUTIONS.....	1
1.1. IMPORTANT! Please read before starting.....	1
1.2. SPECIAL PRECAUTION .....	1
2. PRODUCT SPECIFICATION.....	2
2.1. Precaution for using R410A refrigerant .....	2
2.2. Special tools for R410A .....	2
2.3. Accessories .....	3
2.4. Pipe requirement .....	3
2.5. Electrical requirement.....	3
2.6. Optional parts .....	4
3. INSTALLATION WORK .....	4
3.1. Selecting an installation location .....	4
3.2. Installation dimensions .....	4
3.3A. Installing the unit (Ceiling concealed type).....	5
3.3B. Installing the unit (Wall mounted type/ Floor standing concealed type)....	7
3.4. Drain installation .....	8
3.5. Pipe installation .....	10
3.6. Electrical wiring.....	11
3.7. Remote controller setting.....	13
4. OPTIONAL INSTALLATION WORK .....	13
4.1. Optional kit installation.....	13
4.2. External input and output.....	13
4.3. Remote sensor (Optional parts) .....	14
4.4. IR receiver unit (Optional parts).....	14
4.5. Auto louver grille (Optional parts) .....	14
4.6. Other optional parts .....	14
4.7. Optional parts cable binding .....	15
5. REMOTE CONTROL INSTALLATION .....	15
5.1. Group control.....	15
5.2. Multiple remote control .....	15
5.3. DIP switch 101 setting .....	15
6. FUNCTION SETTING.....	16
6.1. Function details .....	16
7. CHECK LIST.....	18
8. TEST RUN.....	19
8.1. Check items .....	19
8.2. Operation method .....	19
9. FINISHING .....	19
10. CUSTOMER GUIDANCE .....	19
11. ERROR CODES.....	19

**NOTES:** This manual describes how to install the air conditioner described above. Handling and installation shall only be done by professionals as outlined in this manual.

- Installation must be performed in accordance with the requirement of NEC (National Electrical Code) and CEC (Canadian Electrical Code) by authorized personnel only.
- All products are manufactured to metric units and tolerances. United States customary units are provided for reference only. In cases where exact dimensions and tolerances are required, always refer to metric units.

English

Français

Español

## When Servicing

- Turn the power OFF at the main circuit breaker panel before opening the unit to check or repair electrical parts and wiring.
- Keep your fingers and clothing away from any moving parts.
- Clean up the site after you finish, remembering to check that no metal scraps or bits of wiring have been left inside the unit being serviced.
- After installation, explain correct operation to the customer, using the operation manual.

### WARNING

Never touch electrical components immediately after the power supply has been turned off. Electrical shock may occur. After turning off the power, always wait 10 minutes or more before touching electrical components.

- Be sure to read this manual thoroughly before installation.
- The warnings and precautions indicated in this Manual contain important information pertaining to your safety. Be sure to observe them.
- Hand this Manual, together with the operation manual, to the customer. Request the customer to keep them on hand for future use, such as for relocating or repairing the unit.

### WARNING

- Installation of this product must be done by experienced service technicians or professional installers only in accordance with this manual. Installation by nonprofessional or improper installation of the product may cause serious accidents such as injury, water leakage, electric shock, or fire. If the product is installed in disregard of the instructions in this manual, it will void the manufacturer's warranty.
- Do not turn on the power until all work has been completed. Turning on the power before the work is completed can cause serious accidents such as electric shock or fire.
- If refrigerant leaks when you are working, ventilate the area. If the leaking refrigerant is exposed to a direct flame it may produce a toxic gas.
- Do not use this equipment with air or any other unspecified refrigerant in the refrigerant lines. Excess pressure can cause a rupture.
- Installation must be performed in accordance with regulations, codes, or standards for electrical wiring and equipment in each country, region, or the installation place.
- This appliance is not intended for use by persons (including children) with reduced physical, sensory or mental capabilities, or lack of experience and knowledge, unless they have been given supervision or instruction concerning use of the appliance by a person responsible for their safety. Children should be supervised to ensure that they do not play with the appliance.
- Cancer and Reproductive Harm - [www.P65Warnings.ca.gov](http://www.P65Warnings.ca.gov).

### CAUTION

- Read carefully all safety information written in this manual before you install or use the air conditioner.
- Install the product by following local codes and regulations in force at the place of installation, and the instructions provided by the manufacturer.
- This product is part of a set constituting an air conditioner. The product must not be installed alone or be installed with non-authorized device by the manufacturer.
- Always use a separate power supply line protected by a circuit breaker operating on all wires with a distance between contact of 1/8 in (3 mm) for this product.
- To protect the persons, ground (earth) the product correctly, and use the power cable combined with an Earth Leakage Circuit Breaker (ELCB).
- This product is not explosion proof, and therefore should not be installed in explosive atmosphere.
- Do not touch the fins of the heat exchanger. Touching the heat exchanger fins could result in damage to the fins or personal injury such as skin rupture.
- This product contains no user-serviceable parts. Always consult experienced service technicians for repairing.
- When moving or relocating the air conditioner, consult experienced service technicians for disconnection and reinstallation of the product.
- Do not place any other electrical products or household belongings under the product. Condensation dripping from the product might get them wet, and may cause damage or malfunction to the property.

## 2. PRODUCT SPECIFICATION

### 2.1. Precaution for using R410A refrigerant

- The basic installation work procedures are the same as conventional refrigerant (R22) models. However, pay careful attention to the following points:
- Since the working pressure is 1.6 times higher than that of conventional refrigerant (R22) models, some of the piping and installation and service tools are special. (Refer to the following table.) Especially, when replacing a conventional refrigerant (R22) model with a new refrigerant R410A model, always replace the conventional piping and flare nuts with the R410A piping and flare nuts.
- Models that use refrigerant R410A have a different charging port thread diameter to prevent erroneous charging with conventional refrigerant (R22) and for safety. Therefore, check beforehand. [The charging port thread diameter for R410A is 1/2-20 UNF.]
- Be more careful that foreign matter (oil, water, etc.) does not enter the piping than with refrigerant (R22) models. Also, when storing the piping, securely seal the opening by pinching, taping, etc.
- When charging the refrigerant, take into account the slight change in the composition of the gas and liquid phases. And always charge from the liquid phase where refrigerant composition is stable.

### 2.2. Special tools for R410A

Tool name	Contents of change
Gauge manifold	Pressure is high and cannot be measured with a R22 gauge. To prevent erroneous mixing of other refrigerants, the diameter of each port has been changed. It is recommended to use gauge with seals -30 inHg to 768 psi (-0.1 to 5.3 MPa) for high pressure. -30 inHg to 551 psi (-0.1 to 3.8 MPa) for low pressure.
Charge hose	To increase pressure resistance, the hose material and base size were changed.
Vacuum pump	A conventional vacuum pump can be used by installing a vacuum pump adapter.
Gas leakage detector	Special gas leakage detector for HFC refrigerant R410A.

#### Copper pipes

It is necessary to use seamless copper pipes and it is desirable that the amount of residual oil is less than 0.004 oz/100 ft (40 mg/10 m). Do not use copper pipes having a collapsed, deformed or discolored portion (especially on the interior surface). Otherwise, the expansion valve or capillary tube may become blocked with contaminants.

As an air conditioner using R410A incurs pressure higher than when using R22, it is necessary to choose adequate materials.

### WARNING

- Do not use the existing (for R22) piping and flare nuts. If the existing materials are used, the pressure inside the refrigerant cycle will rise and cause failure, injury, etc. (Use the special R410A materials.)
- Use (refill or replace with) specified refrigerant (R410A) only. Use of unspecified refrigerant can cause product malfunction, burst, or injury.
- Do not mix any gas or impurities except specified refrigerant (R410A). Inflow of air or application of unspecified material makes the internal pressure of the refrigerant cycle too high, and may cause product malfunction, burst of piping, or injury.













## 2.3. Accessories

### ⚠ WARNING

For installation purposes, be sure to use the parts supplied by the manufacturer or other prescribed parts. The use of non-prescribed parts can cause serious accidents such as the unit to fall, water leakage, electric shock, or fire.

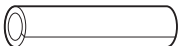
- Keep the Installation Manual in a safe place and do not discard any other accessories until the installation work has been completed.
- The following installation parts are furnished. Use them as required.

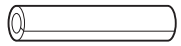
The following installation accessories are supplied. Use them as required.

Name and Shape	Qty	Name and Shape	Qty
Operation manual 	1	Cable tie (large) 	4
Installation manual (This manual) 	1	Cable tie (medium) 	3
Installation template 	1	Filter (large) [18, 24 model] 	[18 model] 2 [24 model] 1
Washer 	8	Filter (small) [07, 09, 12, 24 model] 	2
Drain hose (Ø 3/4 in [I.D.], Ø 1-1/16 in [O.D.]) 	1	Coupler heat insulation (large) 	1
Hose band 	1	Coupler heat insulation (small) 	1
Drain hose insulation B 	1		

The following items are necessary to install this air conditioner. (The items are not included with the air conditioner and must be purchased separately.)

Additional materials	
Connection pipe assembly	Wall cap
Connection cable (4-conductor)	Saddle
Wall pipe	Drain hose
Decorative tape	Tapping screws
Vinyl tape	Putty

## 2.4. Pipe requirement

### ⚠ CAUTION

- Do not use existing pipes from another refrigeration system or refrigerant.
- Use pipes that have clean external and internal sides without any contamination which may cause trouble during use, such as sulfur, oxide, dust, cutting waste, oil, or water.
- It is necessary to use seamless copper pipes.  
Material : Phosphor deoxidized seamless copper pipes  
It is desirable that the amount of residual oil is less than 0.004 oz/100 ft (40 mg/10 m).
- Do not use copper pipes that have a collapsed, deformed, or discolored portion (especially on the interior surface). Otherwise, the expansion valve or capillary tube may become blocked with contaminants.
- Improper pipe selection will degrade performance. As an air conditioner using R410A incurs pressure higher than when using conventional (R22) refrigerant, it is necessary to choose adequate materials.

- Thicknesses of copper pipes used with R410A are as shown in the table.
- Never use copper pipes thinner than those indicated in the table even if they are available on the market.

### Thicknesses of Annealed Copper Pipes (R410A)

Pipe outside diameter [in (mm)]	Thickness [in (mm)]
1/4 (6.35)	0.032 (0.80)
3/8 (9.52)	0.032 (0.80)
1/2 (12.70)	0.032 (0.80)
5/8 (15.88)	0.039 (1.00)
3/4 (19.05)	0.047 (1.20)

### ⚠ CAUTION

Refer to the installation manual for the outdoor unit for description of allowable pipe length and height difference.

Model	Diameter [in (mm)]	
	Liquid	Gas
07, 09, 12	1/4 (6.35)	3/8 (9.52)
18	1/4 (6.35)	1/2 (12.70)
24	1/4 (6.35)	5/8 (15.88)

- Use pipe with water-resistant heat insulation.

### ⚠ CAUTION

- Wrap heat insulation around both gas pipe and liquid pipe.  
No heat-insulation work or incorrect heat-insulation work may cause water leaks.
- In a reverse cycle model, use heat insulation with heat resistance above 248 °F (120 °C).
- If expected humidity of the installation location of refrigerant pipes is higher than 70 %, wrap the heat insulation around the refrigerant pipes.  
If the expected humidity is between 70 % and 80 %, use heat insulation that has a thickness of 9/16 in (15 mm) or more.
- If the expected humidity is higher than 80 %, use heat insulation that has a thickness of 13/16 in (20 mm) or more.
- The use of thinner heat insulation than specified above, may cause a condensation on the surface of the insulation.
- Use heat insulation with thermal conductivity of 0.045 W/(m·K) or less (at 68 °F (20 °C)).

## 2.5. Electrical requirement

The indoor unit is powered from the outdoor unit. Do not power indoor unit from separate power source.

### ⚠ WARNING

Standard for electrical wiring and equipment differs in each country or region. Before you start electrical working, confirm related regulations, codes, or standards.

Cable	Conductor size (AWG)	Remarks
Connection cable	AWG 14	3 cable + Ground (Earth), 1 Ø 230 V

Cable Length: Limit voltage drop to less than 2%. Increase cable gauge if voltage drop is 2% or more.

## 2.6. Optional parts

Refer to each installation manual for the method of installing optional parts.

Parts name	Model No.	Application
Wired remote controller	UTY-RNRUZ*	For air conditioner operation (2-wired type)
Simple remote controller	UTY-RSRY	For air conditioner operation (2-wired type)
	UTY-RHRY	
IR receiver unit	UTY-LBTUM	For the wireless remote controller
Remote sensor unit	UTY-XSZX	Room temperature sensor
Auto louver grille kit	UTD-GXTA-W	Air outlet grille with auto louver (07, 09, 12 model)
	UTD-GXTB-W	Air outlet grille with auto louver (18 model)
	UTD-GXTC-W	Air outlet grille with auto louver (24 model)
External input and output PCB / Box	UTY-XCSX	For external input and output
	UTZ-GXEA	
External connect kit	UTY-XWZXZG	For external output port
W-LAN interface	UTY-TFSXZ2	For wireless LAN interface
Modbus converter	—	Refer to Design & Technical manual.
KNX convertor	—	

## 3. INSTALLATION WORK

### WARNING

- Do not move the appliance by holding the indoor unit pipes. (The stress applied to the pipe joints may cause the flammable gas to leak during operation.)
- Carrying and installation of the unit should be performed by a sufficient number of people and with sufficient equipment that is adequate for the weight of the unit. Performing such work with an insufficient number of people or with inadequate equipment could result in dropping of the unit or personal injury.
- Do not turn on the power until all installation work is complete.

### 3.1. Selecting an installation location

Correct initial installation location is important because it is difficult to move unit after it is installed.

### WARNING

Install the air conditioner in a location which can withstand a load of at least 3 times the weight of the main unit and which will not amplify sound or vibration. If the installation location is not strong enough, the indoor unit may fall and cause injuries.

MODEL	Withstandable weight (Unit weight x 3*)
AR 7/9/12	120 Lbs (54kg)
AR 18	153 Lbs (69kg)
AR 24	179 Lbs (81kg)

\*In accordance with UL standards.

### CAUTION

- Do not install the unit in the following areas:
  - Area with high salt content, such as at the seaside. It will deteriorate metal parts, causing the parts to fail or the unit to leak water.
  - Area filled with mineral oil or containing a large amount of splashed oil or steam, such as a kitchen. It will deteriorate plastic parts, causing the parts to fail or the unit to leak water.
  - Area where is close to heat sources.
  - Area that generates substances that adversely affect the equipment, such as sulfuric gas, chlorine gas, acid, or alkali. It will cause the copper pipes and brazed joints to corrode, which can cause refrigerant leakage.
  - Area that can cause combustible gas to leak, contains suspended carbon fibers or flammable dust, or volatile in flammables such as paint thinner or gasoline.
  - If gas leaks and settles around the unit, it can cause a fire.
  - Area where animals may urinate on the unit or ammonia may be generated.
- Do not use the unit for special purposes, such as storing food, raising animals, growing plants, or preserving precision devices or art objects. It can degrade the quality of the preserved or stored objects.
- Install the unit where drainage does not cause any trouble.
- Do not install where there is the danger of combustible gas leakage.
- Do not install the unit near a source of heat, steam, or flammable gas.
- Install the indoor unit, outdoor unit, power supply cable, transmission cable, and remote control cable at least 40 in (1 m) away from a television or radio receivers. The purpose of this is to prevent TV reception interference or radio noise. (Even if they are installed more than 40 in (1 m) apart, you could still receive noise under some signal conditions.)
- Install the unit where ambient temperature does not reach 140 °F (60 °C) or more. Take a measure such as ventilation for an environment in which heat is retained.
- If children under 10 years old may approach the unit, take preventive measures so that they cannot reach the unit.
- Install the indoor unit on the place where the height from the floor is more than 71 in (1.8 m).
- Use the "Insulation kit for high humidity" (option), when the condition under the roof is over 80% in humidity and over 86 °F (30 °C) in temperature. Otherwise, there is a risk of condensation on the ceiling.

- Decide the mounting position with the customer as follows:

- Install the indoor unit in a location having sufficient strength to support the weight of the indoor unit.
- The inlet and outlet ports should not be obstructed; the air should be able to blow all over the room.
- Leave the space required to service the air conditioner.
- Install the unit where the air can be distributed evenly throughout the room by the unit.
- Install the unit where connection to the outdoor unit is easy.
- Install the unit where the connection pipe can be easily installed.
- Install the unit where the drain pipe can be easily installed.
- Install the unit where noise and vibration is not amplified.
- Take servicing, etc., into consideration and leave the spaces. Also install the unit where the filter can be removed.

## 3.2. Installation dimensions

### 3.2.1. ceiling concealed type

Provide a Service access for inspection purposes.

Do not place any wiring or illumination in the service space, as they will impede service.

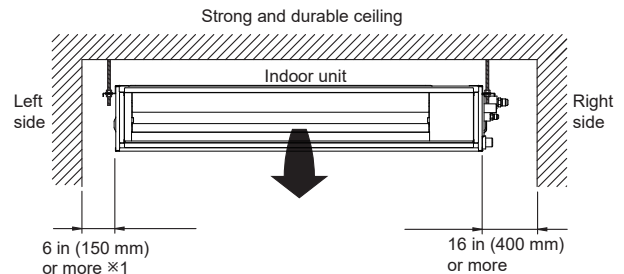

- When intaking air from back

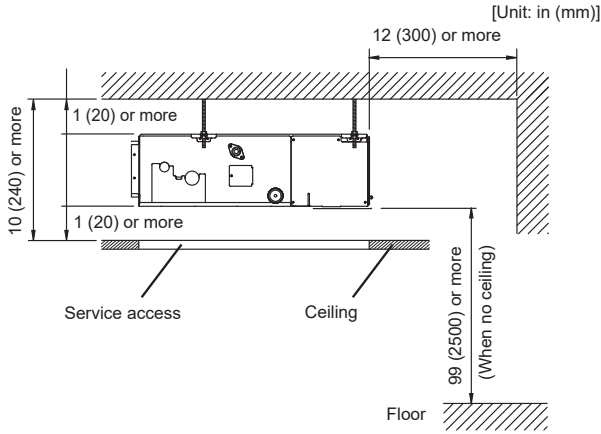

Adjust the wind direction in the room depending on the shape of blow out opening.

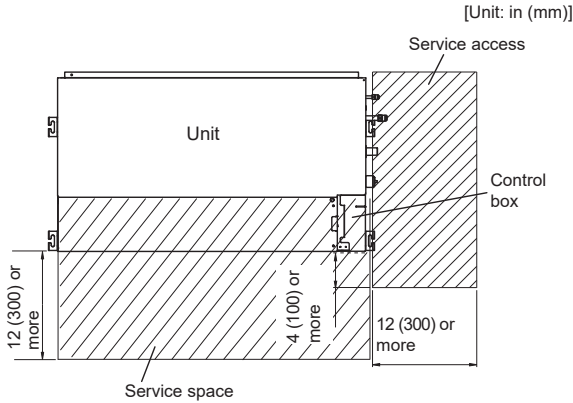

\*: Above 4 in (100 mm) When intaking air from bottom

### 3.2.2. Wall mounted type/ Floor standing concealed type

The wall mounted type/floor standing concealed type requires a temperature correction setting. Perform this in "6. Function setting".

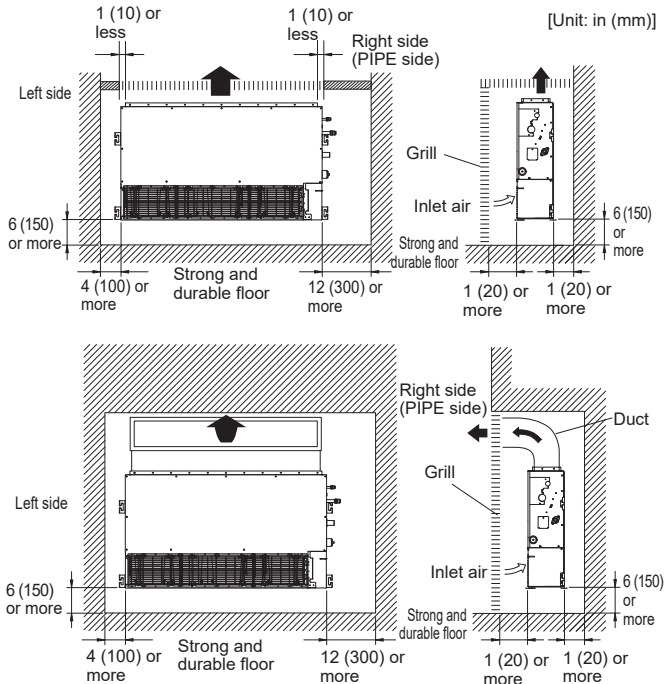

### 3.3A. Installing the unit (Ceiling concealed type)

#### ⚠ WARNING

- Install the air conditioner in a location which can withstand a load do at least 5 times the weight of the main unit and which will not amplify sound or vibration. If the installation location is not strong enough, the indoor unit may fall and cause injuries.
- If the work is done with the panel frame only, there is a risk that the unit will come loose. Take care.

#### 3.3A.1. Unit installation example

##### ■ Connect the locally purchased duct:

- (1) Inlet side
  - Connect the duct to the locally purchased inlet flange.
  - Connect the flange to the body with the locally purchased tapping screws.
  - Wind the inlet flange connecting to the duct with the aluminum tape etc. to avoid the air discharge.

#### ⚠ CAUTION

When the duct is connected to inlet side, remove contained filter and surely attach locally purchased filter at inlet opening.

- (2) Outlet side

- Connect the duct with adjusting inside of outlet flange.
- Wind the outlet flange connecting to the duct with the aluminum tape etc. to avoid the air discharge.
- Insulate the duct to avoid the dew condensation.

#### ⚠ CAUTION

- Confirm the directions of the air intake and outlet before installing the unit. The unit takes in air from the fan side, and expels it from the evaporator side.
- Check that duct work does not exceed the range of external static pressure of equipment.
- Make sure to insulate ducts to avoid the dew condensation.
- Make sure to insulate between ducts and walls if metal ducts are used.
- Explain handling and washing methods of locally purchased materials to the customer.
- To prevent people from touching the parts inside the unit, be sure to install grilles on the inlet and outlet ports. The grilles must be designed in such a way that cannot be removed without tools.
- When connecting the duct to the outlet port of the indoor unit, be sure to insulate the outlet port and the installation screws to prevent water from leaking around the port.
- Set the static pressure of 09, 12 models to 0 to 30 Pa.
- Set the static pressure of 18 model to 0 to 50 Pa.

- Remove the screws, and then remove cover and fan guard.
- Install the cover with the screws as shown in the illustration below.

Model	Screw (The number of screws is different depending on the model.)
07, 09, 12	9
18	11
24	13

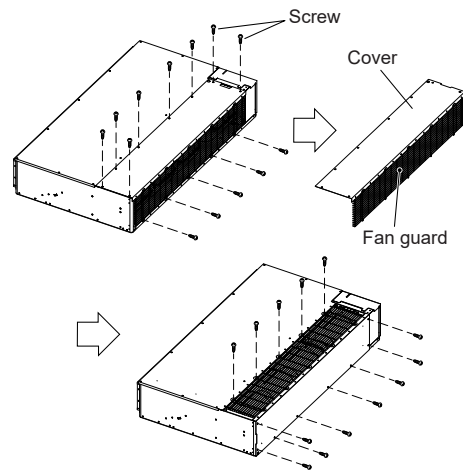

#### ⚠ CAUTION

All items removed (cover, fan guard, screws) must be reinstalled.

### Side inlet - Side outlet

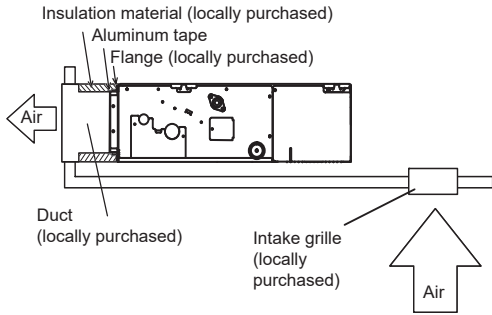

### Side inlet - Side outlet (Duct)

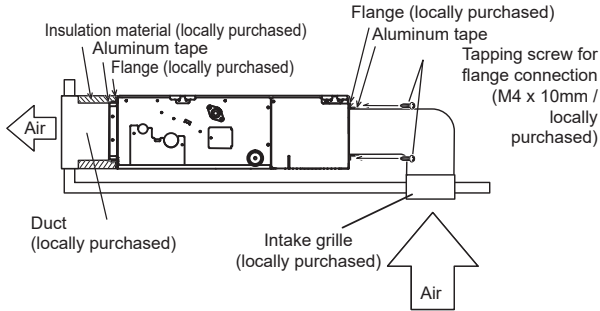

### Bottom inlet - Side outlet

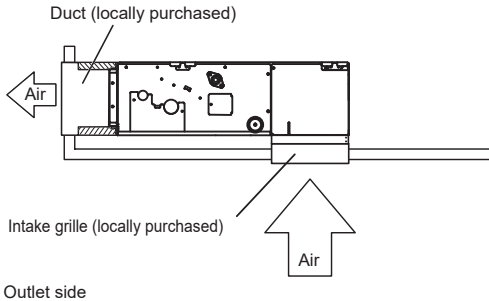

Outlet side

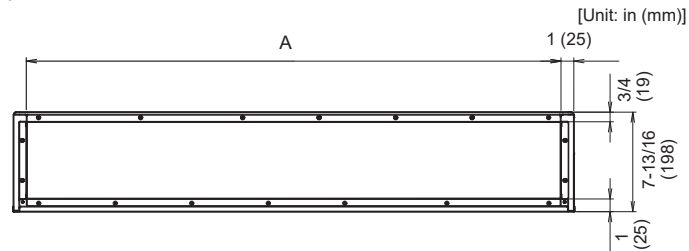

Inlet side

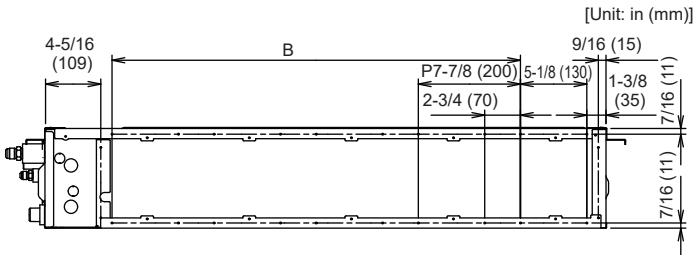

Model	07, 09, 12	18	24
A	25-9/16 in (650 mm)	33-7/16 in (850 mm)	41-5/16 in (1050 mm)
B	P7-7/8 in (200 mm) × 2 = 15-3/4 in (400 mm)	P7-7/8 in (200 mm) × 3 = 23-5/8 in (600 mm)	P7-7/8 in (200 mm) × 4 = 31-1/2 in (800 mm)

### CAUTION

- Be sure to install the air inlet grille and the air outlet grille for air circulation. The correct temperature cannot be detected.
- Grills must be fixed so that man cannot touch indoor unit fan and exchanger, and cannot be removed by only hand operation without tool.
- Be sure to install the air filter in the air inlet.  
If the air filter is not installed, the heat exchanger may be clogged and its performance may decrease.

### 3.3A.2. Install the filters

- Install the filters to the unit.

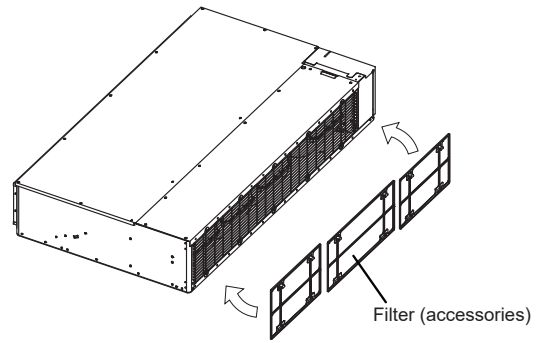

07, 09, 12, 18 model: 2 filters  
24 model: 3 filters

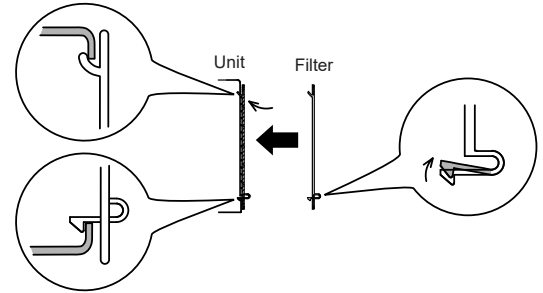

### 3.3A.3. Position the ceiling hole and hanging bolts

- Using the installation template, drill holes for bolts (4 holes).
- Using the installation template, drill holes for bolts (4 holes).

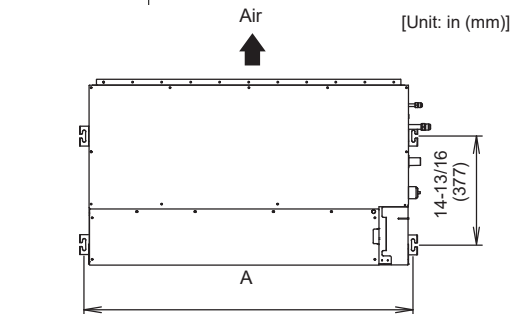
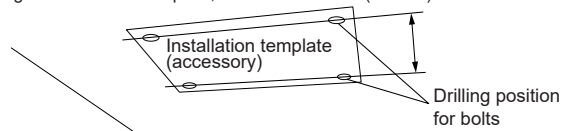

Model	07, 09, 12	18	24
A	28-7/8 in (734 mm)	36-3/4 in (934 mm)	44-5/8 in (1134 mm)

### 3.3A.4. Fix the unit

(1) Hang the unit

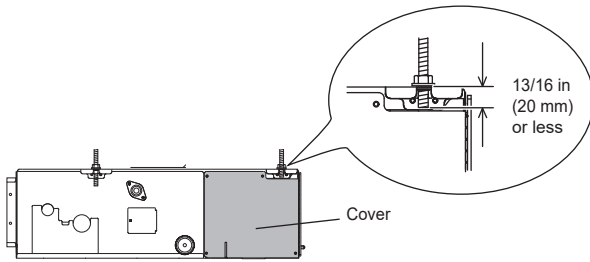
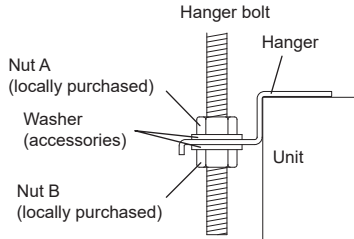
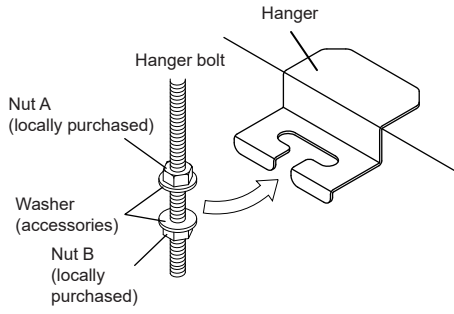

\* It might become difficult to open and shut the Cover /control box cover when the length exceeds 13/16 in (20 mm).

(2) Leveling

Base horizontal direction leveling on top of the unit.

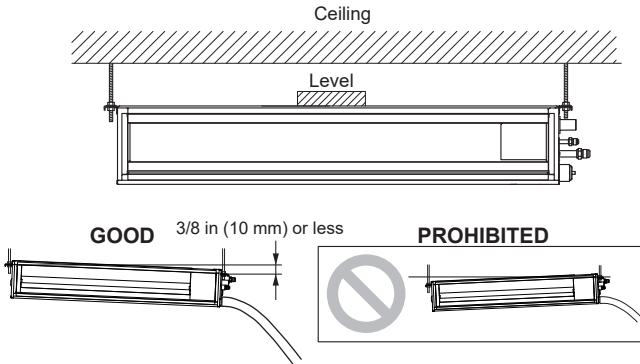

Give a slight tilt to the side to which the drain hose is connected. The tilt should be in the range of 0 to 3/8 in (0 to 10 mm).

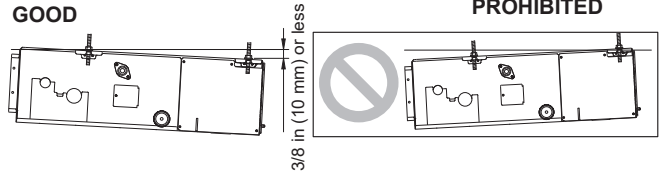
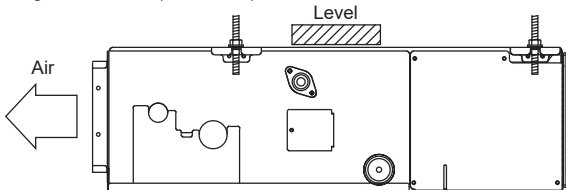

**CAUTION**

- Leave a space of 3-15/16 in (100 mm) or more between the inlet port and the ceiling.
- Fasten the unit securely with Special nuts A and B.

### 3.3B. Installing the unit (Wall mounted type/ Floor standing concealed type)

**WARNING**

- Install the air conditioner in a location which can withstand a load do at least 5 times the weight of the main unit and which will not amplify sound or vibration. If the installation location is not strong enough, the indoor unit may fall and cause injuries.
- If the job is done with the panel frame only, there is a risk that the unit will come loose. Take care.

#### 3.3B.1. Unit installation example

##### ■ Connect the locally purchased duct:

(1) Inlet side

- Connect the duct to the locally purchased inlet flange.
- Connect the flange to the body with the locally purchased tapping screws.
- Wind the inlet flange connecting to the duct with the aluminum tape etc. to avoid the air discharge.

**CAUTION**

When the duct is connected to inlet side, remove filter provided with unit and attach locally purchased filter at return air grille or in return duct.

(2) Outlet side

- Connect the duct to outlet flange.
- Wind the outlet flange connecting to the duct with aluminum tape etc. to avoid the air discharge.
- Insulate the duct to avoid condensation.

**CAUTION**

- Check that duct work does not exceed the range of external static pressure of equipment.
- Make sure to insulate ducts to avoid condensation.
- Make sure to insulate between ducts and walls if metal ducts are used.
- Explain handling and washing methods of locally purchased materials to the customer.
- To prevent people from touching the parts inside the unit, be sure to install grilles on the inlet and outlet ports. The grilles must be designed in such a way that cannot be removed without tools.
- When connecting the duct to the outlet port of the indoor unit, be sure to insulate the outlet port and the installation screws to prevent water from leaking around the port.
- Set the static pressure of 09, 12 models to 0 to 30 Pa.
- Set the static pressure of 18 model to 0 to 50 Pa.

- Remove the screws, and then remove cover and fan guard.
- Install the cover with the screws as shown in the illustration below.

Model	Screw (The number of screws is different depending on the model.)
07, 09, 12	9
18	11
24	13

### 3.3B.2. Install the filters

- Install the filters (accessories) to the unit.

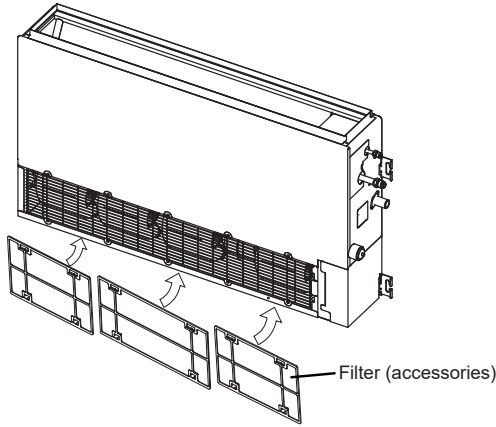

07, 09, 12, 18 model: 2 filters  
24 model: 3 filters

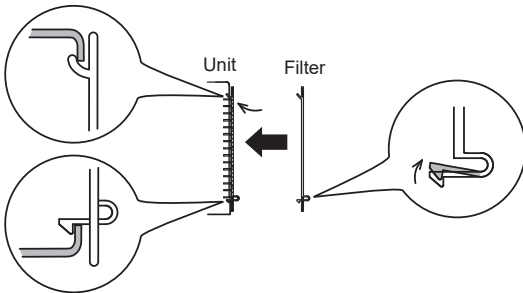

### 3.3B.3. Install the unit

- To prevent overturning, attach the unit to the floor or the wall.
- To avoid vibration of the unit, install vibration isolation pad between the unit and the floor or the wall.

(1) Leveling

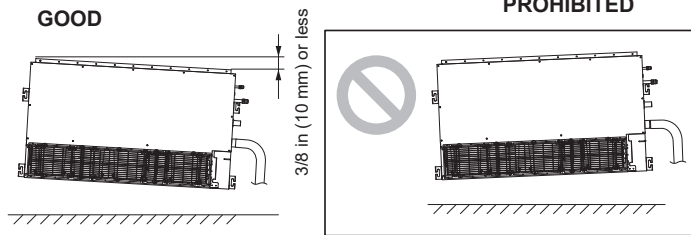
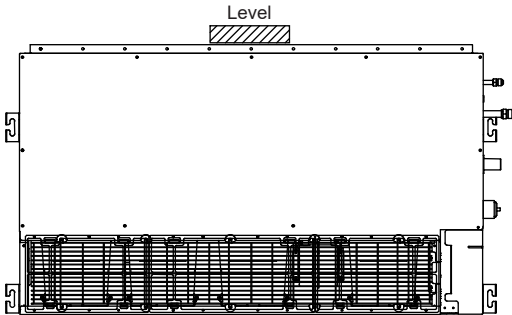

GOOD

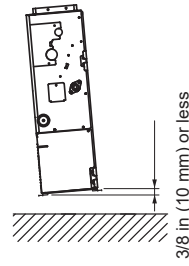

PROHIBITED

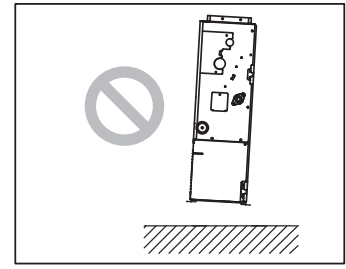

**CAUTION**

- Fasten the unit securely with Special nuts A and B.

## 3.4. Drain installation

### 3.4.1. Installing drain pipes

**WARNING**

- Do not insert the drain piping into the sewer where sulfurous gas occurs. (Heat exchange erosion may occur)
- Insulate the parts properly so that water will not drip from the connection parts.
- Check for proper drainage after the construction by using the visible portion of transparent drain port and the drain piping final outlet on the body.

**CAUTION**

Do not apply adhesive agent on the drain port of the body.  
(Use the attached drain hose and connect the drain piping)

#### ■ When drain pump is used

- Use general hard polyvinyl chloride pipe ( $\varnothing$  3/4 in [I.D.];  $\varnothing$  1-1/16 in [O.D.]).
- Do not perform a rise, trap and air bleeding.
- Provide a downward gradient (1/100 or more).
- Provide supporters when long pipes are installed.
- Use an insulation material as needed, to prevent the pipes from freezing.
- Install the pipes in a way that allows for the removal of the control box.

GOOD

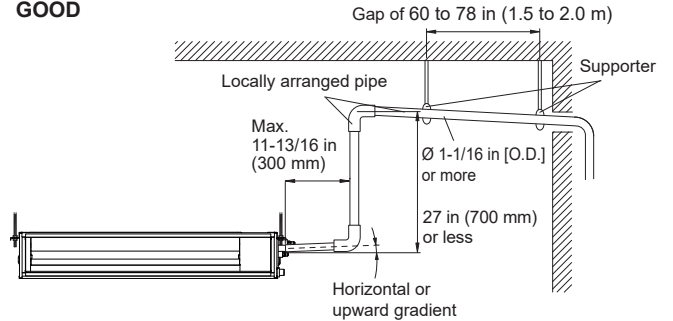

PROHIBITED

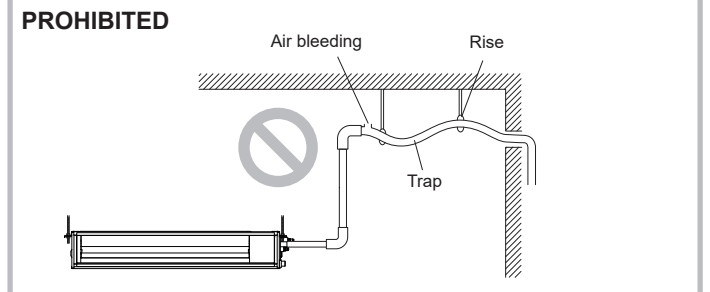

Observe the following procedures to construct centralized drain pipe fittings.



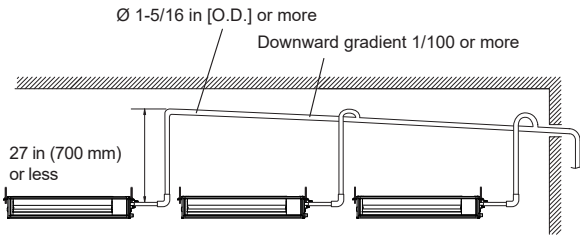

■ When drain pump is not used (natural drainage)

**CAUTION**

Set "Drainage function setting (DIP switch 101-1)" in "5.3. DIP switch 101 setting"

If the drain pump is not used, replace with the drain cap.

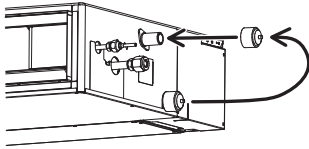

- Use general hard polyvinyl chloride pipe ( $\varnothing 3/4$  in [I.D.];  $\varnothing 1-1/16$  in [O.D.]).
- Do not perform a rise, trap and air bleeding.
- Provide a downward gradient (1/100 or more).
- Provide supporters when long pipes are installed.
- Use an insulation material as needed, to prevent the pipes from freezing.
- Install the pipes in a way that allows for the removal of the control box.

**GOOD**

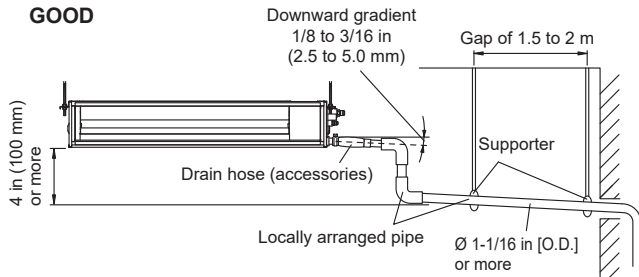

**PROHIBITED**

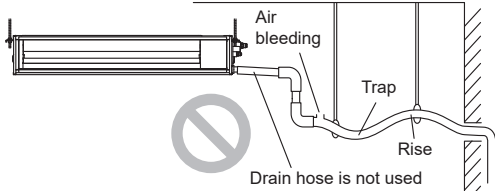

Observe the following procedures to construct centralized drain pipe fittings.

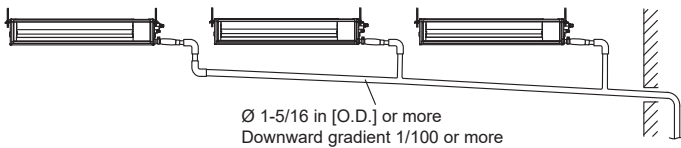

**3.4.2. Installing the drain hose (accessory) and drain pipe (locally purchased)**

(1) Be sure to use supplied Drain hose and Hose band

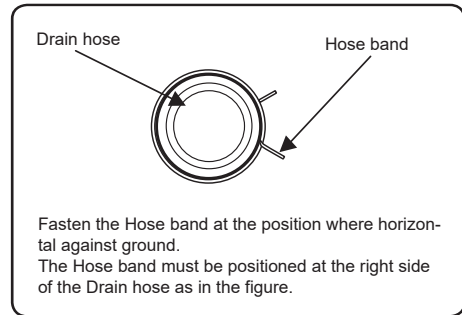
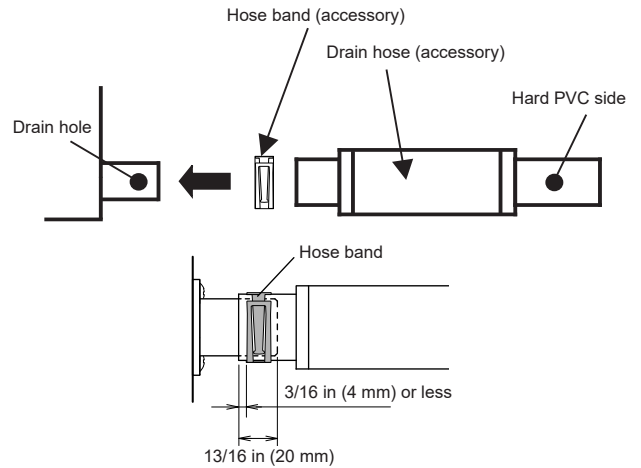

(2) Be sure to connect Drain pipe with adhesive (polyvinyl chloride) so that there is no leakage.

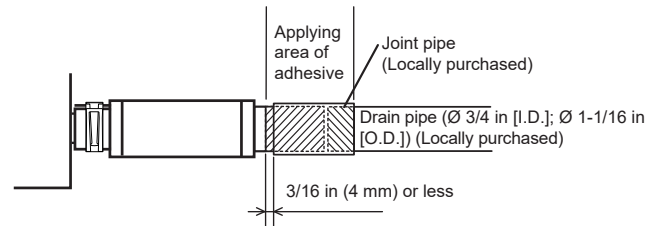

**CAUTION**

Do not connect to the Drain hole with adhesive. Using adhesive may cause damage and water leaks.

(3) After installing the Drain hose, check if the drainage is smooth.

**CAUTION**

To prevent excessive force on Drain hose, avoid bends or twists. (To bend or twist may cause water leaks.)

(4) After checking for drainage, attach the Drain hose insulation B to insulate, following the instructions as in the figures. To avoid space with Drain hose and Hose band, press firmly the Drain hose insulation B.

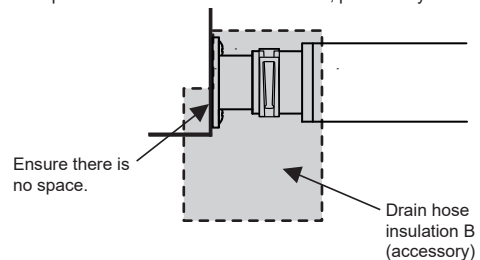

• STEP 1 to STEP 3

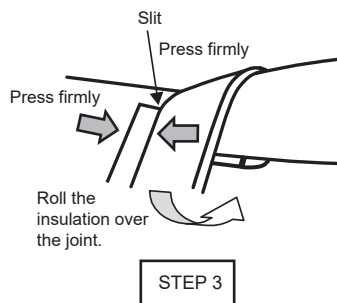
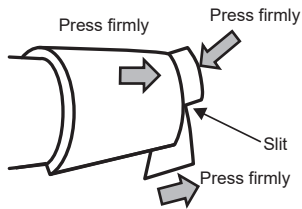
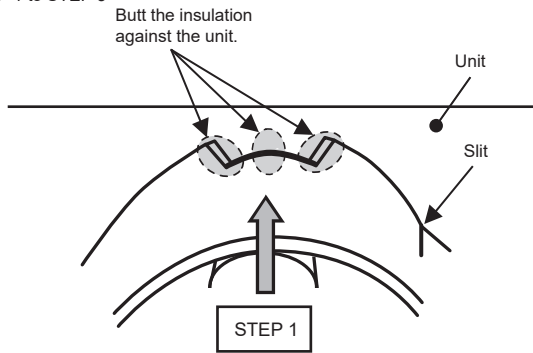

• FINISH

Check that there is no gap between the unit and the drain hose insulation.

• When drain pump is used.

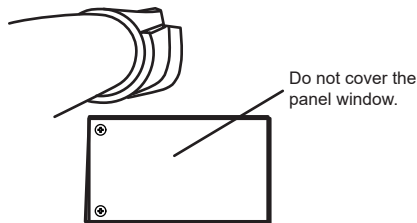

• When drain pump is not used. (Natural drainage)

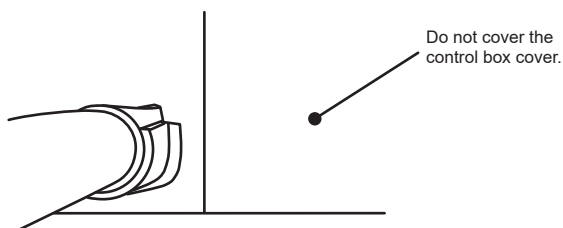

**NOTE: Check for drainage (When drain pump is used)**

Pour about 1 liter of water from the position shown in the diagram or from the airflow outlet to the dew tray. Check for any abnormalities such as strange noises and whether the drain pump functions normally.

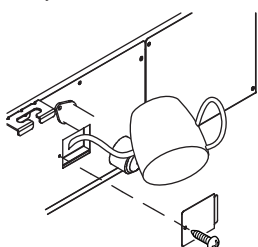

**NOTE: Check for drainage (When drain pump is not used)**

Pour about 1 liter of water from the airflow outlet to the dew tray. Check for any abnormalities such as strange noises.

**CAUTION**

Make sure the drain water is properly drained.

**3.5. Pipe installation**

**3.5.1. Pipe connection**

**CAUTION**

Tighten the flare nuts with a torque wrench using the specified tightening method. Otherwise, the flare nuts could break after a prolonged period, causing refrigerant to leak and generate hazardous gas if the refrigerant comes into contact with a flame.

**Flaring**

Use special pipe cutter and flare tool designed for R410A pipework.

- (1) Cut the connection pipe to the necessary length with a pipe cutter.
- (2) Hold the pipe downward so that cuttings will not enter the pipe and remove any burrs.
- (3) Insert the flare nut (always use the flare nut attached to the indoor unit(s) and outdoor unit or branch box respectively) onto the pipe and perform the flare processing with a flare tool. Use the special R410A flare tool, or the conventional flare tool. Leakage of refrigerant may result if other flare nuts are used.
- (4) Protect the pipes by pinching them or with tape to prevent dust, dirt, or water from entering the pipes.

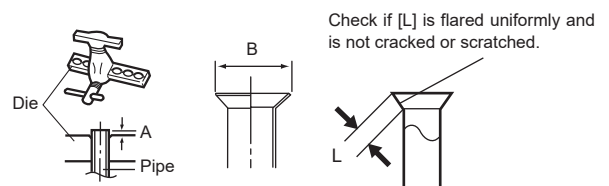

Pipe outside diameter [in (mm)]	Dimension A [in (mm)]	Dimension B [in (mm)]
	Flare tool for R410A, clutch type	
1/4 (6.35)	0 to 0.020 (0 to 0.5)	3/8 (9.1)
3/8 (9.52)		1/2 (13.2)
1/2 (12.70)		5/8 (16.6)
5/8 (15.88)		3/4 (19.7)
3/4 (19.05)		15/16 (24.0)

When using conventional flare tools to flare R410A pipes, the dimension A should be approximately 0.020 in (0.5 mm) more than indicated in the table (for flaring with R410A flare tools) to achieve the specified flaring. Use a thickness gauge to measure the dimension A.

Width across flats	Pipe outside diameter [in (mm)]	Width across flats of Flare nut [in (mm)]
	1/4 (6.35)	11/16 (17)
	3/8 (9.52)	7/8 (22)
	1/2 (12.70)	1 (26)
	5/8 (15.88)	1-1/8 (29)
	3/4 (19.05)	1-7/16 (36)

**Bending pipes**

**CAUTION**

- To prevent breaking of the pipe, avoid sharp bends.
- If the pipe is bent repeatedly at the same place, it will break.

- The pipes are shaped by your hands. Be careful not to collapse them.
- Bend R 2-3/4 in (70 mm) or more with a pipe bender.
- Do not bend the pipes in an angle more than 90°.
- When pipes are repeatedly bent or stretched, the material will harden, making it difficult to bend or stretch them anymore.
- Do not bend or stretch the pipes more than 3 times.
- When bending the pipe, do not bend it as is. The pipe will be collapsed. In this case, cut the insulating pipe with a sharp cutter as shown on the right, and bend it after exposing the pipe. After bending the pipe as you want, be sure to put the heat insulating pipe back on the pipe, and secure it with tape.

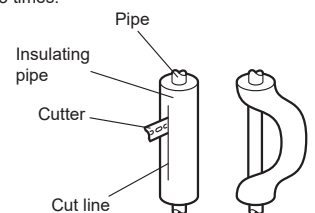

## ■ Flare connection

### ⚠ CAUTION

- Be sure to install the pipe against the port on the indoor unit correctly. If the centering is improper, the flare nut cannot be tightened smoothly. If the flare nut is forced to turn, the threads will be damaged.
- Do not remove the flare nut from the indoor unit pipe until immediately before connecting the connection pipe.
- Hold the torque wrench at its grip, keeping it in the right angle with the pipe, in order to tighten the flare nut correctly.
- Tighten the flare nuts with a torque wrench using the specified tightening method. Otherwise, the flare nuts could break after a prolonged period, causing refrigerant to leak and generate hazardous gas if the refrigerant comes into contact with a flame.
- Connect the piping so that the control box cover can easily be removed for servicing when necessary.
- In order to prevent water from leaking into the control box, make sure that the piping is well insulated.
- When flared joints are reused indoors, the flare part shall be re-fabricated.

When the flare nut is tightened properly by your hand, hold the body side coupling with a wrench, then tighten with a torque wrench. (Refer to the following table for the flare nut tightening torques.)

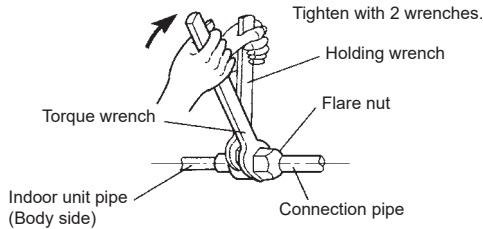

Flare nut [in (mm)]	Tightening torque [ft-lb (N·m)]
1/4 (6.35) dia.	12 to 13 (16 to 18)
3/8 (9.52) dia.	24 to 31 (32 to 42)
1/2 (12.70) dia.	36 to 45 (49 to 61)
5/8 (15.88) dia.	46 to 55 (63 to 75)
3/4 (19.05) dia.	66 to 81 (90 to 110)

Do not remove the cap from the connection pipe before connecting the pipe.

## 3.6. Electrical wiring

### ⚠ WARNING

- Electrical work must be performed in accordance with this Manual by a person certified under the national or regional regulations. Be sure to use a dedicated circuit for the unit. An insufficient power supply circuit or improperly performed electrical work can cause serious accidents such as electric shock or fire.
- Before starting work, check that power is not being supplied to the indoor unit and outdoor unit.
- For wiring, use the prescribed type of cables, connect them securely, making sure that there are no external forces of the cables applied to the terminal connections. Improperly connected or secured cables can cause serious accidents such as overheating the terminals, electric shock, or fire.
- Securely install the electrical box cover on the unit. An improperly installed electrical box cover can cause serious accidents such as electric shock or fire through exposure to dust or water.
- Install sleeves into any holes made in the walls for wiring. Otherwise, a short circuit could result.
- Use the included connection cables and power cables or ones specified by the manufacturer. Improper connections, insufficient insulation, or exceeding the allowable current can cause electric shock or fire.
- Do not modify the power cables, use extension cables, or use any branches in the wiring. Improper connections, insufficient insulation, or exceeding the allowable current can cause electric shock or fire.
- Match the terminal block numbers and connection cable colors with those of the outdoor unit or branch box. Erroneous wiring may cause burning of the electric parts.
- Securely connect the connection cables to the terminal board. In addition, secure the cables with wiring holders. Improper connections, either in the wiring or at the ends of the wiring, can cause a malfunction, electric shock, or fire.
- Always fasten the outside covering of the connection cable. (If the insulator is chafed, electric leakage may occur.)
- Install an earth leakage breaker. In addition, install the earth leakage breaker so that the entire AC main power supply is cut off at the same time. Otherwise, electric shock or fire could result.
- Always connect the ground (earth) cable. Improper grounding (earthing) work can cause electric shocks.
- Perform wiring work in accordance with standards so that the air conditioner can be operated safely and positively.
- Connect the connection cable firmly to the terminal board. Imperfect installation may cause a fire.
- Use ring terminals and tighten the terminal screws to the specified torques, otherwise, abnormal overheating may be produced and possibly cause heavy damage inside the unit.
- Install the remote controller cables so as not to be touched directly with your hand.
- Perform wiring work in accordance with standards so that the air conditioner can be operated safely and positively.
- Unit shall be grounded (earthed) in compliance with the applicable local and national codes.

### ⚠ CAUTION

- Be careful not to generate a spark as follows for using a flammable refrigerant.
  - Do not remove the fuse while the power is on.
  - Do not disconnect the wiring while the power is on.
  - It is recommended to position the outlet connection in a high position. Place the cords so that they do not get tangled.
- Ground (Earth) the unit. Do not connect the ground (earth) cable to a gas pipe, water pipe, lightning rod, or a telephone ground (earth) cable. Improper grounding (earthing) may cause electric shock.
- Install the remote controller cables so as not to be direct touched with your hand.
- Do not connect power supply cables to the transmission or remote controller terminals, as this will damage the product.
- Never bundle the power supply cable and transmission cable, remote controller cable together. Separate these cable by 2 in (50 mm) or more. Bundling these cables together will cause miss operation or breakdown.
- When handling PCB, static electricity charged in the body may cause malfunction of the PCB. Follow the cautions below:
  - Establish a ground (an earth) for the indoor and outdoor units and peripheral devices.
  - Cut power (breaker) off.
  - Touch metal part of the indoor and outdoor units for more than 10 seconds to discharge static electricity charged in the body.
  - Do not touch terminals of parts and patterns implemented on PCB.
- Be sure to refer to the following diagram for do correct field wiring. Wrong wiring causes malfunction of the unit.
- Check local electrical rules and also any specific wiring instructions or limitation.

### 3.6.1. Wiring system diagram

#### ■ Standard pair

##### Connection cable

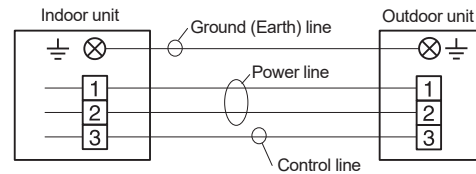

#### Wired remote controller cable

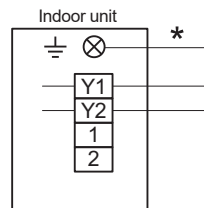

#### ■ Flexible multi-split type

##### Connection cable

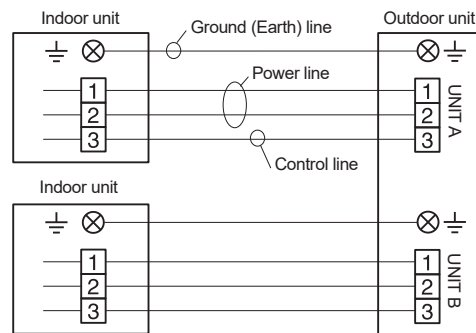

#### Wired remote controller cable

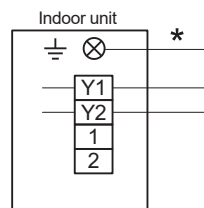

\*Ground (Earth) the remote controller if it has an ground (earth) line.

### 3.6.2. Connection cable preparation

#### ■ Connection cable

Keep the ground (earth) wire longer than the other wires.

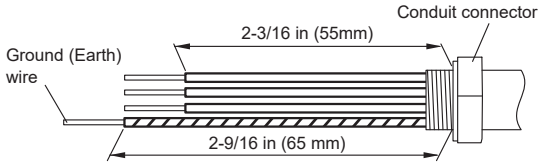

- Use a 4-core wire cable.

#### ■ Remote controller cable

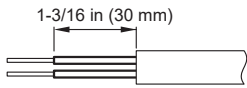

### 3.6.3. How to connect wiring to the terminals

#### ■ Caution when wiring cable

To strip off the insulation of a lead wire, always use a special tool such as a wire stripper. If there is no special tool, carefully strip off the insulation by using a knife or other utensil.

- (1) Use ring terminals with insulating sleeves as shown in the figure to connect to the terminal block.
- (2) Securely clamp the ring terminals to the wires by using an appropriate tool so that the wires do not come loose.

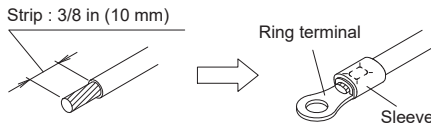

- (3) Connect specified wires securely, and fasten them so that there is no stress applied on the terminals.
- (4) Use a screwdriver with an appropriate bit size to tighten the terminal screws. Using of screwdriver with inappropriate bit size will damage the screw heads, and the screws will not be tightened properly.
- (5) Do not overtighten the terminal screws. Otherwise, the screws may break.

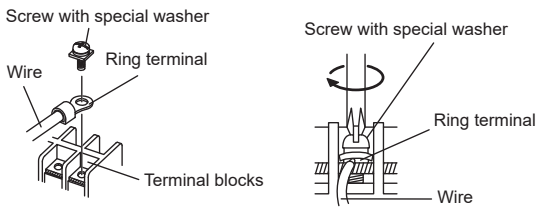

- (6) Refer to the table for the terminal screw tightening torques.
- (7) Do not fix 2 power supply cables with 1 screw.

Tightening torque [lbf·in (N·m)]	
M4 screw	11 to 16 (1.2 to 1.8)

### 3.6.4. Connection wiring

#### ⚠ CAUTION

- Be careful not to mistake the power supply cable and connection wires when installing.
- Install so that the wires for the remote controller will not come in contact with other connection wires.

- (1) Remove the control box cover
- (2) Connect the connection cable.

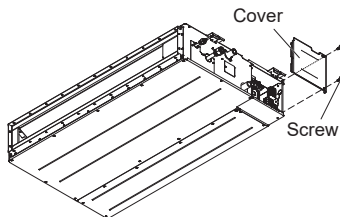

#### ■ Connection cable

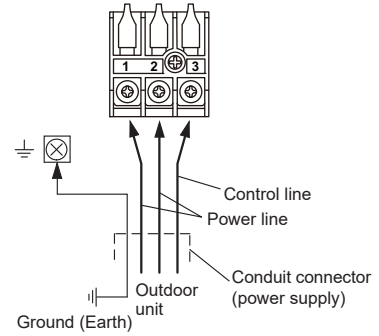

#### ■ Remote controller cable

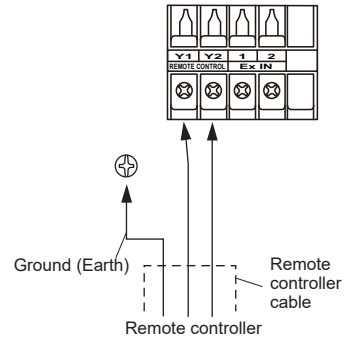

\*Ground (Earth) the remote controller if it has a ground (earth) wire.

- (3) After wiring is complete, secure the remote controller cable, conduit connector.

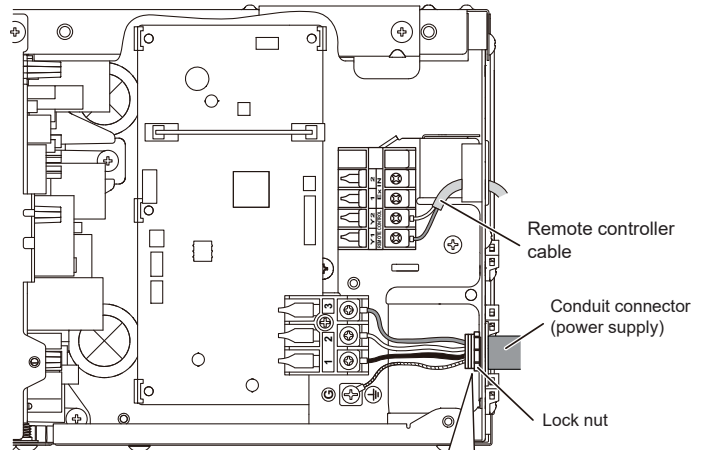

Attach the conduit connector on the wiring connecting port. (The grommet edging and the connection cable clamp are not used.)

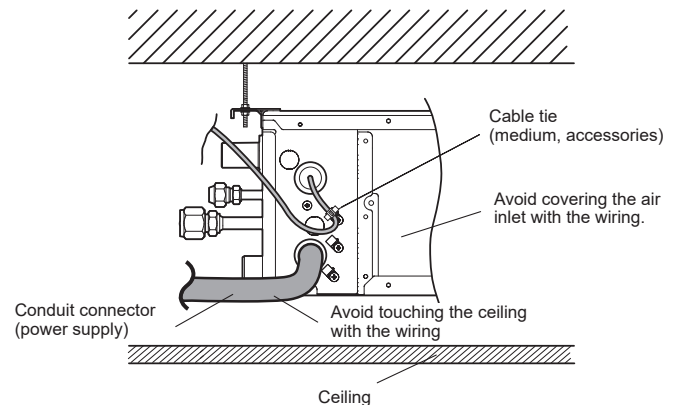
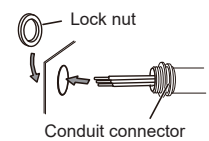

Do not bind the power supply cable and other cables together.

- (4) Seal the cable outlet or other gaps with putty to prevent dew condensation or insect from entering the electric control box.
- (5) Replace the control box cover.
- (6) Fix the conduit with the supporters as shown below.

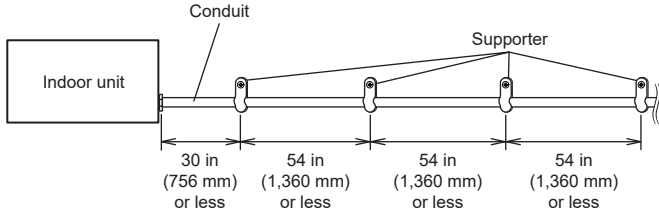

### CAUTION

Do not bundle the remote controller cable, or wire the remote controller cable in parallel, with the indoor unit connection wire (to the outdoor unit) and the power supply cable. It may cause erroneous operation.

## 3.7. Remote controller setting

To install and set the remote controller, refer to the installation manual of the remote controller.

## 4. OPTIONAL INSTALLATION WORK

### 4.1. Optional kit installation

#### WARNING

Regulation of cable differs from each locality, refer in accordance with local rules.

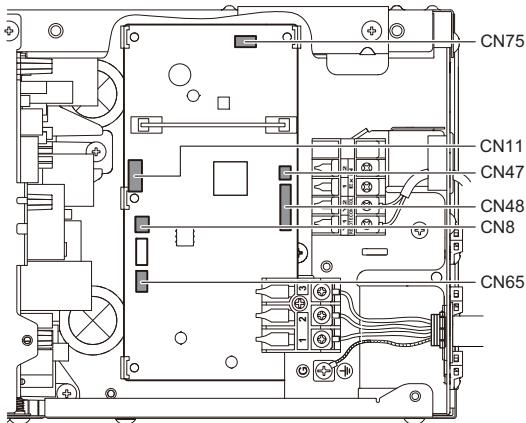

This air conditioner can be connected with the following optional kits.  
For details on how to install optional parts, refer to the installation manual included in each item.

Connector No.	Option type
CN47*1	External output
CN8	Remote sensor
CN48	IR Receiver
CN11	Auto louver grille kit
CN65	Other optional parts (External input and output PCB, Modbus converter, KNX converter, W-LAN interface *2 etc.) may be connectable. Refer to the technical data for details.
CN75	

\*1: For external output terminal setting, refer to Function No.60 in "6. FUNCTION SETTING".

\*2: Be sure to connect the W-LAN interface to CN75.

### 4.2. External input and output

#### 4.2.1. External input

- Indoor unit functions such as Operation/Stop or Forced stop can be done by using indoor unit terminals.
- "Operation/Stop" mode or "Forced stop" mode can be selected with function setting of indoor unit.
- A twisted pair cable (22 AWG) should be used. Maximum length of cable is 150 m (492 ft.).
- Use an external input and output cable with appropriate external dimension, depending on the number of cables to be installed.
- The wire connection should be separate from the power cable line.

#### Terminal

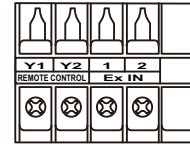

Connected device

#### • Dry contact terminal

When a power supply is unnecessary at the input device you want to connect, use the Dry contact terminal.

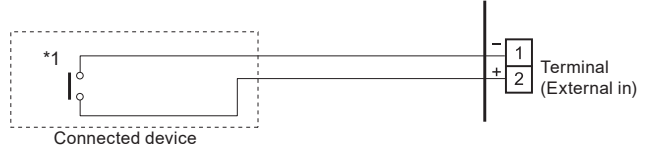

\*1: The switch can be used on the following condition: DC 12 V to 24 V, 1 mA to 15 mA.

#### ■ Operation behavior

##### • Input signal type



When function setting is "Operation/Stop" mode 1.

Input signal	Command
OFF → ON	Operation
ON → OFF	Stop

When function setting is "Forced stop" mode.

Input signal	Command
OFF → ON	Forced stop
ON → OFF	Normal

\* When the forced stop is triggered, indoor unit stops and Operation/Stop operation by a remote controller is restricted.

When function setting is "Operation/Stop" mode 2.

Input signal	Command
OFF → ON	Operation
ON → OFF	Stop (R.C. disabled)

#### 4.2.2. External output

- A twisted pair cable (22AWG) should be used. Maximum length of cable is 82 ft (25 m).
- Use an external input and output cable with appropriate external dimension, depending on the number of cables to be installed.
- Output voltage: Hi DC12V±2V, Lo 0V.
- Permissible current: 50mA

#### ■ Output select

When interlocking with external device

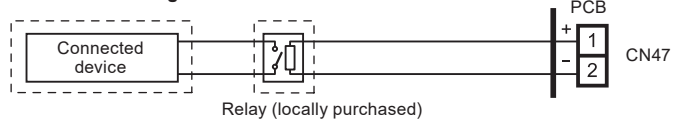

or  
When displaying "Operation/Stop"

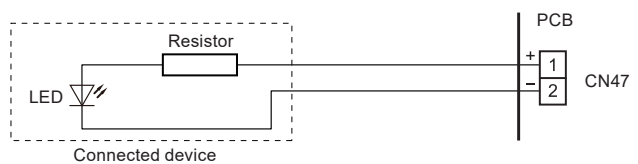

## ■ Operation behavior

Functions of the external output terminal can be switched.

(◀... Factory setting)

Function setting	Status	Output voltage
00	Stop	0 V
	Operation	DC 12 V
01 - 04	OFF	0 V
	Cooling thermostat ON	DC 12 V
05	OFF	0 V
	Heating operation ON	DC 12 V
06	Stop	0 V
	Operation	DC 12 V
07 - 08	OFF	0 V
	Cooling thermostat ON	DC 12 V
09	Normal	0 V
	Error	DC 12 V
10	Indoor unit fan stop	0 V
	Indoor unit fan operation	DC 12 V
11	External heater OFF	0 V
	External heater ON	DC 12 V

Refer to the Design & technical manual.

### 4.2.3. Connection methods

#### ■ Wire modification

- Remove insulation from wire attached to wire kit connector.
- Remove insulation from locally purchased cable. Use crimp type insulated butt connector to join field cable and wire kit wire.
- Connect the wire with connecting wire with solder.

**IMPORTANT:** Be sure to insulate the connection between the wires.

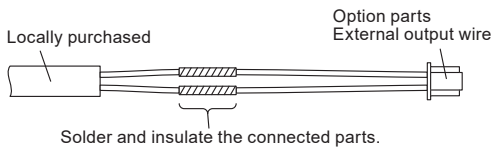

- Connecting wires to the terminals.  
Use ring terminals with insulating sleeves to connect to the terminal block.
- Connection terminals and wiring arrangement (Refer to "4.6. Other optional parts")

## 4.3. Remote sensor (Optional parts)

### 4.3.1. Connection method

- Remove the existing connector and replace it with the remote sensor connector (ensure that the correct connector is used).
- The original connector should be insulated to ensure that it does not come into contact with other electrical circuitry.
- Connection terminals and wiring arrangement. (Refer to "4.6. Other optional parts")

### 4.3.2. Setting for room temperature correction

When a remote sensor is connected, set the function setting of indoor unit as indicated below.

- Function Number "30":  
Set the Setting Number to "00". (Default)
- Function Number "31":  
Set the Setting Number to "01".

\* Refer to "6. FUNCTION SETTING" for details about Function number and Setting value

## 4.4. IR receiver unit (Optional parts)

- For the installation method, refer to the installation manual of IR receiver unit.

### 4.4.1. Connection method

- Use 9 pins for receiver unit cable.
- At first, connect the receiver unit cable to the controller PCB.
- Attach the core that comes between controller PCB and the clamp.
- Connection terminals and wiring arrangement. (Refer to "4.6. Other optional parts").

## 4.5. Auto louver grille (Optional parts)

### 4.5.1. Connection method

- Wiring arrangement

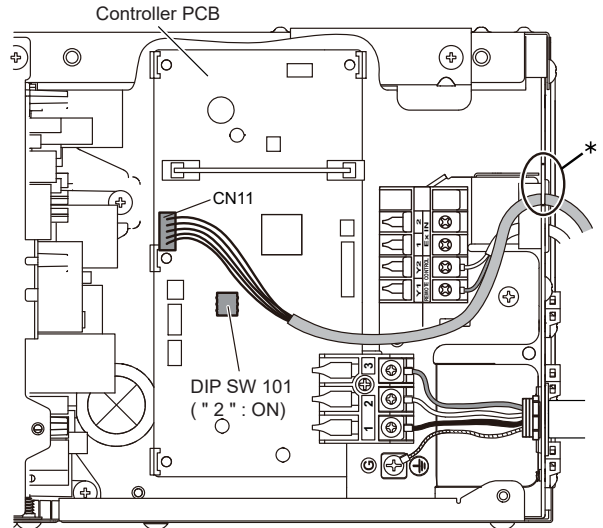

#### \* ⚠ CAUTION

To protect the cable insulation after opening a knockout hole, remove any burrs from the edge of the hole.

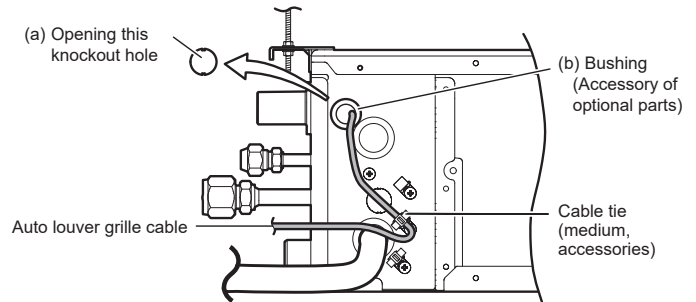

## 4.6. Other optional parts

### 4.6.1. Connection method

- Connection terminals and wiring arrangement

In following figure, all the possible connections are done for description.  
In actual installation, connections will differ according to each installation requirements.

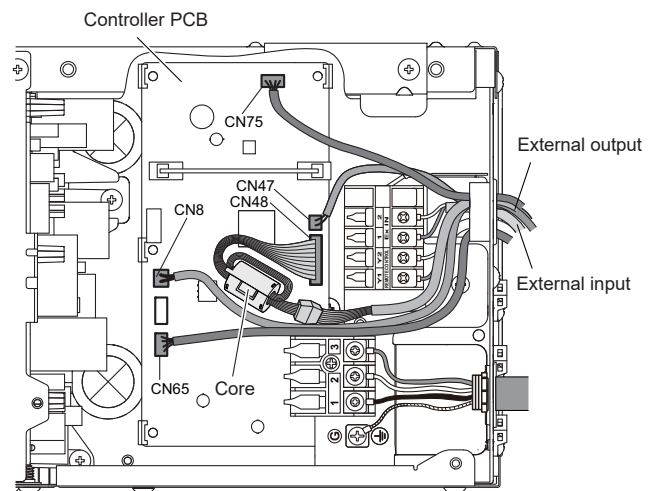

## 4.7. Optional parts cable binding

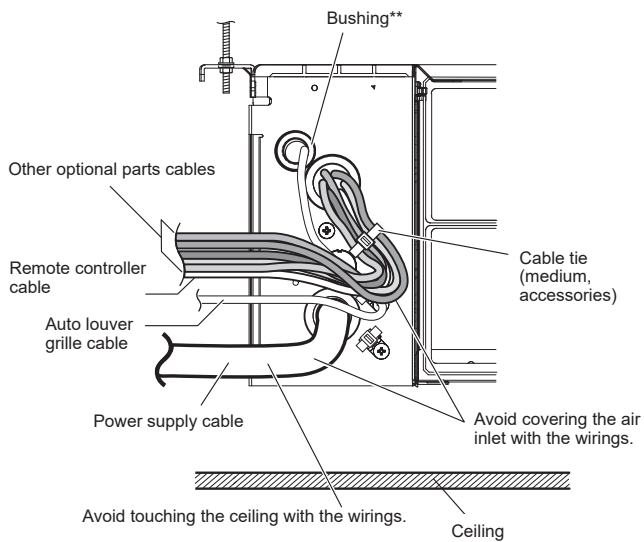

- \* Use an accessory of indoor unit or optional parts for cable tie.
- \*\* Use an accessory of optional parts for bushing.

- Do not bind the power supply cable and other cables together.

### CAUTION

To protect the cable insulation after opening a knockout hole, remove any burrs from the edge of the hole.

## 5. REMOTE CONTROL INSTALLATION

### 5.1. Group control

A number of indoor units can be operated at the same time using a single remote controller.  
\*When different types of indoor units (such as wall mounted type and cassette type, cassette type and duct type, or other combinations) are connected using group control system, some functions may no longer be available.

Connect up to 16 indoor units in a system.

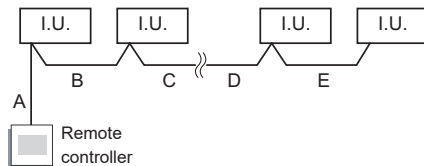

A, B, C, D, E : Remote controller cable.  
A+B+C+D+E ≤ 1,640 ft (500 m).

Example of wiring method

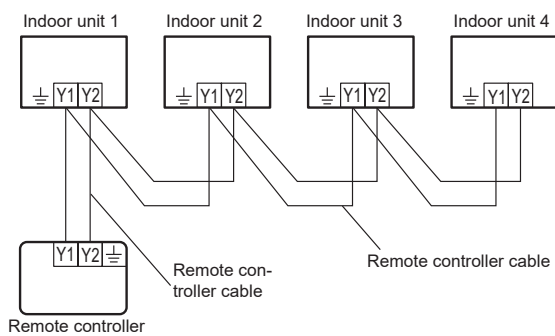

## 5.2. Multiple remote control

Up to 2 remote controllers can be used to operate one indoor unit

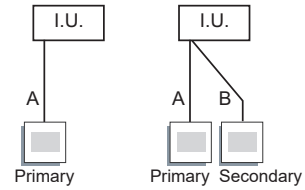

A, B : Remote controller cable. (Refer to "2.5. Electrical requirement")  
A ≤ 1,640 ft (500 m), A+B ≤ 1,640 ft (500 m)

- The timer and self-diagnosis functions cannot be used on the secondary units.

(1) Wiring method (indoor unit to remote controller)

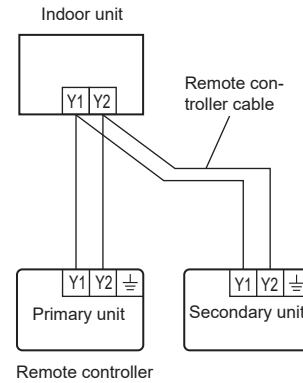

### 5.3. DIP switch 101 setting

- (1) If contained drain pump is not used, set the drainage function to "Disable" in the drainage function switching.
- (2) The auto louver grille setting (optional parts) can be used when the it is mounted. For the setting method, refer to "4.5. Auto louver grille (Optional parts)".
- (3) The fan delay setting can be used when the auxiliary heater is mounted. When the operation is stopped when the indoor unit is operating with an auxiliary heater, the operation continues 1 minutes.

Change the following settings by using the DIP switch.

(♦... Factory setting)

	DIP switch 101	DIP SW state		Details
		ON	OFF	
(1)	1	Disable	Enable ♦	Drainage function setting
(2)	2	Enable	Disable ♦	Auto louver grille setting
(3)	3	Enable	Disable ♦	Fan delay setting

#### • Switching position

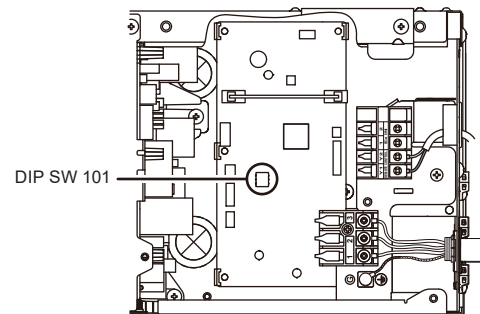

## 6. FUNCTION SETTING

### 6.1. Function details

#### ■ Filter sign

Select appropriate intervals for displaying the filter sign on the indoor unit according to the estimated amount of dust in the air of the room.

If the indication is not required, select "No indication" (03).

(◆... Factory setting)

Function number	Setting value	Setting description
11	00	Standard (400 hours)
	01	Long interval (1000 hours)
	02	Short interval (200 hours)
	03	No indication

#### ■ Static pressure

#### ⚠ CAUTION

If the applicable static pressure does not match the static pressure mode, the static pressure mode may be changed to another mode manually.

Select the appropriate static pressure according to the installation conditions.

It is necessary to set up a static pressure mode for each usage of static pressure. Static pressure can be set at site.

Relation between set values and static pressure are as the following table.

- Function setting can be performed with the wired or wireless remote controller. (The remote controller is optional equipment)
- Refer to the wired or wireless remote controller manual for detailed setting information.

(◆... Factory setting)

Function number	Setting value	Setting description
26	00	0 in WG (0 Pa)
	01	0.04 in WG (10 Pa)
	02	0.08 in WG (20 Pa)
	03	0.12 in WG (30 Pa)
	04	0.16 in WG (40 Pa)
	05	0.20 in WG (50 Pa)
	06	0.24 in WG (60 Pa)
	07	0.28 in WG (70 Pa)
	08	0.32 in WG (80 Pa)
	09	0.36 in WG (90 Pa)
31	◆ 0.10 in WG (25 Pa) [Standard]	

Range of static pressure is different by model.

Model	Range of static pressure
07	0 to 0.36 in WG (0 to 90 Pa)
09	
12	
18	
24	0 to 0.2 in WG (0 to 50 Pa)

#### ■ Room temperature control for indoor unit sensor

Depending on the installed environment, correction of the room temperature sensor may be required.

Select the appropriate control setting according to the installed environment.

The temperature correction values show the difference from the "Standard setting" (00) (manufacturer's recommended value).

(◆... Factory setting)

Function number	Setting value	Setting description	
30 (For cooling)	31 (For heating)	00	Standard setting
		01	No correction 0 °F (0.0 °C)
		02	-1 °F (-0.5 °C)
		03	-2 °F (-1.0 °C)
		04	-3 °F (-1.5 °C)
		05	-4 °F (-2.0 °C)
		06	-5 °F (-2.5 °C)
		07	-6 °F (-3.0 °C)
		08	-7 °F (-3.5 °C)
		09	-8 °F (-4.0 °C)
		10	+1 °F (+0.5 °C)
		11	+2 °F (+1.0 °C)
		12	+3 °F (+1.5 °C)
		13	+4 °F (+2.0 °C)
		14	+5 °F (+2.5 °C)
		15	+6 °F (+3.0 °C)
		16	+7 °F (+3.5 °C)
17	+8 °F (+4.0 °C)		

#### ■ Room temperature control for wired remote controller sensor

Depending on the installed environment, correction of the wire remote temperature sensor may be required.

Select the appropriate control setting according to the installed environment.

To change this setting, set Function 42 to "Both" (01).

Ensure that the Thermo Sensor icon is displayed on the remote controller screen.

(◆... Factory setting)

Function number	Setting value	Setting description	
35 (For cooling)	36 (For heating)	00	No correction
		01	No correction 0 °F (0.0 °C)
		02	-1 °F (-0.5 °C)
		03	-2 °F (-1.0 °C)
		04	-3 °F (-1.5 °C)
		05	-4 °F (-2.0 °C)
		06	-5 °F (-2.5 °C)
		07	-6 °F (-3.0 °C)
		08	-7 °F (-3.5 °C)
		09	-8 °F (-4.0 °C)
		10	+1 °F (+0.5 °C)
		11	+2 °F (+1.0 °C)
		12	+3 °F (+1.5 °C)
		13	+4 °F (+2.0 °C)
		14	+5 °F (+2.5 °C)
		15	+6 °F (+3.0 °C)
		16	+7 °F (+3.5 °C)
17	+8 °F (+4.0 °C)		

#### ■ Auto restart

Enable or disable automatic restart after a power interruption.

(◆... Factory setting)

Function number	Setting value	Setting description
40	00	Enable
	01	Disable

\* Auto restart is an emergency function such as for power outage etc. Do not attempt to use this function in normal operation. Be sure to operate the unit by remote controller or external device.

#### ■ Room temperature sensor switching

(Only for wired remote controller)

When using the wired remote controller temperature sensor, change the setting to "Both" (01).

(◆... Factory setting)

Function number	Setting value	Setting description
42	00	Indoor unit
	01	Both

00: Sensor on the indoor unit is active.

01: Sensors on both indoor unit and wired remote controller are active.

\* Remote controller sensor must be turned on by using the remote controller



### Remote controller custom code

(Only for wireless remote controller)  
The indoor unit custom code can be changed. Select the appropriate custom code.  
(◆... Factory setting)

Function number	Setting value	Setting description
44	00	A
	01	B
	02	C
	03	D

### External input control

"Operation/Stop" mode or "Forced stop" mode can be selected.  
(◆... Factory setting)

Function number	Setting value	Setting description
46	00	Operation/Stop mode 1
	01	(Setting prohibited)
	02	Forced stop mode
	03	Operation/Stop mode 2

### Room temperature sensor switching (Aux.)

To use the temperature sensor on the wired remote controller only, change the setting to "Wired remote controller" (01). This function will only work if the function setting 42 is set at "Both" (01)  
(◆... Factory setting)

Function number	Setting value	Setting description
48	00	Both
	01	Wired remote controller

### Indoor unit fan control for energy saving for cooling

Enables or disables the power-saving function by controlling the indoor unit fan rotation when the outdoor unit is stopped during cooling operation.  
(◆... Factory setting)

Function number	Setting value	Setting description
49	00	Disable
	01	Enable
	02	Remote controller

00: When the outdoor unit is stopped, the indoor unit fan operates continuously following the setting on the remote controller.

01: When the outdoor unit is stopped, the indoor unit fan operates intermittently at a very low speed.

02: Enable or disable this function by remote controller setting.

\*When using a wired remote controller without Indoor unit fan control for energy saving for cooling function, or when connecting a single split converter, the setting cannot be made by using the remote controller. Set to (00) or (01).

To confirm if the remote controller has this function, refer to the operation manual of each remote controller.

### Switching functions for external output terminal

Functions of the external output terminal can be switched.  
(◆... Factory setting)

Function number	Setting value	Setting description
60	00	Operation status
	01-04	Cooling thermostat status
	05	Heating operation status
	06	Operation status
	07-08	Cooling thermostat status
	09	Error status
	10	Fresh air control
	11	Auxiliary heater

Refer to the Design & technical manual.

### Control switching of external heaters

Sets the control method for the external heater being used.  
For details of the control method, refer to the Design & Technical Manual.  
(◆... Factory setting)

Function number	Setting value	Setting description
61	00	Auxiliary heater control 1
	01	Auxiliary heater control 2
	02	Heat pump prohibition control
	03	Heater selection control using outdoor temperature 1
	04	Heater selection control using outdoor temperature 2
	05	Auxiliary heater control by outdoor temperature 3
	06	Auxiliary heat pump control
	07	Auxiliary heat pump control by outdoor temperature 1
	08	Auxiliary heat pump control by outdoor temperature 2
09	Auxiliary heat pump control by outdoor temperature 3	

### Operating temperature switching of external heaters

- Sets the temperature conditions when the external heater is ON.
- For the temperature conditions, refer to "Temperature conditions when the external heater is ON". For a more detailed explanation, refer to the Design & Technical Manual.  
(◆... Factory setting)

Function number	Setting value	Setting description
62	00	Setting 0
	01	Setting 1
	02	Setting 2
	03	Setting 3
	04	Setting 4
	05	Setting 5
	06	Setting 6
	07	Setting 7
	08	Setting 8
	09	Setting 9
	10	Setting 10
	11	Setting 11
	12	Setting 12
	13	Setting 13
	14	Setting 14
	15	Setting 15
	16	Setting 16
17	Setting 17	

### Temperature conditions when the external heater is ON/OFF

Temperature (t) = Room temperature - set temperatur

		Set value of function: 61			
		00		01 to 09	
		ON	OFF	ON	OFF
Set value of function: 62	00	t < -5.4°F (-3°C)	t ≥ -1.8°F (-1°C)	t ≤ -0.9°F (-0.5°C)	t ≥ +0.9°F (+0.5°C)
	01	t < -3.6°F (-2°C)	t ≥ -1.8°F (-1°C)	t ≤ -1.8°F (-1°C)	t ≥ +0.9°F (+0.5°C)
	02	t < -3.6°F (-2°C)	t ≥ -1.8°F (-1°C)	t ≤ -3.6°F (-2°C)	t ≥ +0.9°F (+0.5°C)
	03	t < -5.4°F (-3°C)	t ≥ -1.8°F (-1°C)	t ≤ -5.4°F (-3°C)	t ≥ +0.9°F (+0.5°C)
	04	t < -7.2°F (-4°C)	t ≥ -1.8°F (-1°C)	t ≤ -7.2°F (-4°C)	t ≥ +0.9°F (+0.5°C)
	05	t < -9.0°F (-5°C)	t ≥ -1.8°F (-1°C)	t ≤ -9.0°F (-5°C)	t ≥ +0.9°F (+0.5°C)
	06	t < -5.4°F (-3°C)	t ≥ -0.9°F (-0.5°C)	t ≤ -0.9°F (-0.5°C)	t ≥ 0°F (0°C)
	07	t < -3.6°F (-2°C)	t ≥ -0.9°F (-0.5°C)	t ≤ -1.8°F (-1°C)	t ≥ 0°F (0°C)
	08	t < -3.6°F (-2°C)	t ≥ -0.9°F (-0.5°C)	t ≤ -3.6°F (-2°C)	t ≥ 0°F (0°C)
	09	t < -5.4°F (-3°C)	t ≥ -0.9°F (-0.5°C)	t ≤ -5.4°F (-3°C)	t ≥ 0°F (0°C)
	10	t < -7.2°F (-4°C)	t ≥ -0.9°F (-0.5°C)	t ≤ -7.2°F (-4°C)	t ≥ 0°F (0°C)
	11	t < -9.0°F (-5°C)	t ≥ -0.9°F (-0.5°C)	t ≤ -9.0°F (-5°C)	t ≥ 0°F (0°C)
	12	t < -5.4°F (-3°C)	t ≥ 0°F (0°C)	t ≤ -0.9°F (-0.5°C)	t ≥ -0.9°F (-0.5°C)
	13	t < -3.6°F (-2°C)	t ≥ 0°F (0°C)	t ≤ -1.8°F (-1°C)	t ≥ -0.9°F (-0.5°C)
	14	t < -3.6°F (-2°C)	t ≥ 0°F (0°C)	t ≤ -3.6°F (-2°C)	t ≥ -0.9°F (-0.5°C)
	15	t < -5.4°F (-3°C)	t ≥ 0°F (0°C)	t ≤ -5.4°F (-3°C)	t ≥ -0.9°F (-0.5°C)
	16	t < -7.2°F (-4°C)	t ≥ 0°F (0°C)	t ≤ -7.2°F (-4°C)	t ≥ -0.9°F (-0.5°C)
17	t < -9.0°F (-5°C)	t ≥ 0°F (0°C)	t ≤ -9.0°F (-5°C)	t ≥ -0.9°F (-0.5°C)	

### ■ Outdoor temperature zone boundary temperature A

Setting required if changing of the outdoor temperature setting for heat pump prohibition zone is required when auxiliary heater control by outdoor temperature 1 and 2 are performed on the indoor unit.

For details of the control method, refer to the Design & Technical Manual.

(◆... Factory setting)

Function number	Setting value	Setting description
66	00	-4.0 °F (-20 °C)
	01	-0.4 °F (-18 °C)
	02	3.2 °F (-16 °C)
	03	6.8 °F (-14 °C)
	04	10.4 °F (-12 °C)
	05	14.0 °F (-10 °C)
	06	17.6 °F (-8 °C)
	07	21.2 °F (-6 °C)
	08	24.8 °F (-4 °C)

### ■ Outdoor temperature zone boundary temperature B

Setting required if changing of the outdoor temperature setting for heat pump only zone is required when auxiliary heater control by outdoor temperature 1 is performed on the indoor unit.

For details of the control method, refer to the Design & Technical Manual.

(◆... Factory setting)

Function number	Setting value	Setting description
67	00	42.8 °F (6 °C)
	01	14.0 °F (-10 °C)
	02	17.6 °F (-8 °C)
	03	21.2 °F (-6 °C)
	04	24.8 °F (-4 °C)
	05	28.4 °F (-2 °C)
	06	32.0 °F (0 °C)
	07	35.6 °F (2 °C)
	08	39.2 °F (4 °C)
	09	42.8 °F (6 °C)
	10	46.4 °F (8 °C)
	11	50.0 °F (10 °C)
	12	53.6 °F (12 °C)
	13	57.2 °F (14 °C)
	14	60.8 °F (16 °C)
	15	64.4 °F (18 °C)

### ■ Standby time for auxiliary equipment operation

Sets the standby time until the auxiliary equipment operation starts during primary equipment operation.

(◆... Factory setting)

Function number	Setting value	Setting description
71	00	Disable
	01	1 minutes
	02	2 minutes
	⋮	⋮
	98	98 minutes
	99	99 minutes

### ■ Heat pump backup setting

Enables or disables the heat pump backup instruction from the outdoor unit. This function will be usable provided that the corresponding outdoor unit is connected.

(◆... Factory setting)

Function number	Setting value	Setting description
72	00	Disable
	01	Enable

### ■ Emergency heat for external output terminal

Enables or disables emergency heat input.

To use this function, select "External heater output" after entering "Function Number 60". For more information, refer to the Design & technical manual.

(◆... Factory setting)

Function number	Setting value	Setting description
73	00	Disable
	01	Enable

### ■ Fan delay time

Sets the fan delay time when the heater is turned off.

(◆... Factory setting)

Function number	Setting value	Setting description
74	00	1 minutes
	01	50 seconds
	02	40 seconds
	03	30 seconds

### ■ External heater use in defrosting

Enables or disables the external heater use in defrosting.

When using function, inappropriate heater selection may cause cold air in defrosting.

(◆... Factory setting)

Function number	Setting value	Setting description
75	00	Disable
	01	Enable

### ■ Setting record

Record any changes to the settings in the following table.

No.	Setting description	Setting value
11	Filter sign	
26	Static pressure	
30	Room temperature control for indoor unit sensor	Cooling
31		Heating
35	Room temperature control for wired remote controller sensor	Cooling
36		Heating
40	Auto restart	
42	Room temperature sensor switching	
44	Remote controller custom code	
46	External input control	
48	Room temperature sensor switching (Aux.)	
49	Indoor unit fan control for energy saving for cooling	
60	Switching functions for external output terminal	
61	Control switching of external heaters	
62	Operating temperature switching of external heaters	
66	Outdoor temperature zone boundary temperature A	
67	Outdoor temperature zone boundary temperature B	
71	Standby time for auxiliary equipment operation	
72	Heat pump backup setting	
73	Emergency heat for external output terminal	
74	Fan delay time	
75	External heater use in defrosting	

After completing the Function Setting, be sure to turn off the power and turn it on again.

## 7. CHECK LIST

Pay special attention to the check items below when installing the indoor unit(s). After installation is complete, be sure to check the following check items again.

Check items	Check box
Has the indoor unit been installed correctly?	
Has there been a check for gas leaks (refrigerant pipes)?	
Has heat insulation work been completed?	
Does water drain easily from the indoor units?	
Is the voltage of the power source the same as that indicated on the label on the indoor unit?	
Are the wires and pipes all connected completely?	
Is the indoor unit grounded?	
Is the connection cable the specified thickness?	
Are the inlets and outlets free of any obstacles?	
After installation is completed, has the proper operation and handling been explained to the user?	
Operate the unit according to the operation manual provided, and check that it is operating normally.	

## 8. TEST RUN

### 8.1. Check items

- Is operation of each button on the remote controller normal?
- Does each lamp light normally?
- Is the drain normal?
- Do not have an abnormal noise and vibration during operation?

Do not operate the air conditioner in test run for a long time.

### 8.2. Operation method

Depending on your installation, choose from the following:

#### ■ By the wireless remote controller (with [TEST RUN] button)

- (1) To start test run, press [START/STOP] and [TEST RUN] on the remote controller.
- (2) To end test run, press [START/STOP] on the remote controller.

#### ■ By the indoor unit or IR receiver unit

- (1) To start test run, press [MANUAL AUTO] of the unit for more than 10 seconds (forced cooling).
  - (2) To end test run, press [MANUAL AUTO] for more than 3 seconds or press [START/STOP] on the remote controller.
- The Operation indicator lamp and Timer indicator lamp will simultaneously flash during the test run mode.

#### ■ By the wired remote controller

- (1) For the operation method, refer to the installation manual and the operation manual of the wired remote controller.

Heating test run will begin in a few minutes when HEAT is selected by the remote controller [reverse cycle model only].

## 9. FINISHING

Install the heat insulation material after performing a refrigerant leak check (Refer to the Installation manual for the outdoor unit for details).

### ■ Coupler heat insulation

#### ⚠ CAUTION

- There should be no gaps between the insulation and the product.
- After checking for gas leaks (refer to the Installation Manual of the outdoor unit), perform this section.
- Install heat insulation around both the large (gas) and small (liquid) pipes. Failure to do so may cause water leaks.

- Insulate with the coupler heat insulation (accessories) around the gas pipe and liquid pipe at indoor unit.
- After installing the coupler heat insulation, wrap both ends with vinyl tape so that there is no gap.
- After affixing the coupler heat insulation, secure it with 2 cable tie (large, accessories), one on each end of the insulation.
- Make sure that the cable tie overlap the heat insulation pipe.

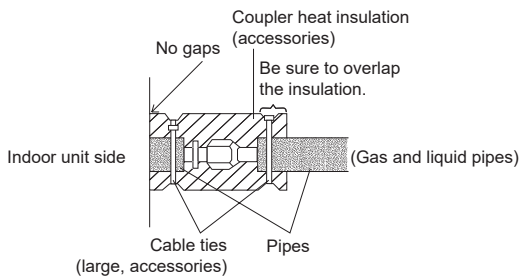

## 10. CUSTOMER GUIDANCE

Explain the following to the customer in accordance with the operation manual:

- (1) Starting and stopping method, operation switching, temperature adjustment, timer, air flow switching, and other remote controller operations.
- (2) Cleaning and maintenance of the product, and other items such as air filters and air louvers if applicable.
- (3) Give the operation and installation manuals to the customer.
- (4) If the indoor unit custom code is changed, and the installation includes a wireless remote controller, inform the customer the changed code. (On some wireless remote controllers, the custom code may return to A when batteries are replaced.)

## 11. ERROR CODES

If you use a wireless remote controller, the lamp on the photo detector unit will output error codes by way of blinking patterns. If you use a wired remote controller, error codes will appear on the remote control display. Refer to the lamp blinking patterns and error codes in the table. An error display is displayed only during operation.

The error code contains errors irrelevant to this product as well.

Error display			Error code	Description
OPERATION lamp (green)	TIMER lamp (orange)	ECONOMY lamp (green)		
●(1)	●(1)	◇	11	Serial communication error
●(1)	●(2)	◇	12	• Wired remote controller communication error • Server room control communication error
●(1)	●(5)	◇	15	Check run unfinished Automatic airflow adjustment error
●(1)	●(6)	◇	16	Peripheral unit transmission PCB connection error
●(1)	●(8)	◇	18	External communication error
●(2)	●(1)	◇	21	Unit number or Refrigerant circuit address setting error [Simultaneous multi-split type]
●(2)	●(2)	◇	22	Indoor unit capacity error
●(2)	●(3)	◇	23	Combination error
●(2)	●(4)	◇	24	• Connection unit number error (indoor secondary unit) [Simultaneous multi-split type] • Connection unit number error (indoor unit or branch unit) [Flexible multi-split type]
●(2)	●(6)	◇	26	Indoor unit address setting error
●(2)	●(7)	◇	27	Primary unit, secondary unit setup error [Simultaneous multi-split type]
●(2)	●(9)	◇	29	Connection unit number error in wired remote controller system
●(3)	●(1)	◇	31	Power supply interruption error
●(3)	●(2)	◇	32	Indoor unit PCB model information error
●(3)	●(3)	◇	33	Indoor unit motor electricity consumption detection error
●(3)	●(5)	◇	35	Manual auto switch error
●(3)	●(9)	◇	39	Indoor unit power supply error for fan motor
●(3)	●(10)	◇	3A	Indoor unit communication circuit (wired remote controller) error
●(4)	●(1)	◇	41	Room temp. sensor error
●(4)	●(2)	◇	42	Indoor unit heat ex. middle temp. sensor error
●(4)	●(4)	◇	44	Human sensor error
●(5)	●(1)	◇	51	Indoor unit fan motor error
●(5)	●(3)	◇	53	Drain pump error
●(5)	●(4)	◇	54	Electric air cleaner reverse VDD error
●(5)	●(5)	◇	55	Filter set error
●(5)	●(7)	◇	57	Damper error
●(5)	●(8)	◇	58	Intake grille error
●(5)	●(9)	◇	59	Indoor unit fan motor 2 error (Left side fan)
●(5)	●(10)	◇	5A	Indoor unit fan motor 3 error (Right side fan)
●(5)	●(15)	◇	5U	Indoor unit error
●(6)	●(1)	◇	61	Outdoor unit reverse/missing phase and wiring error

Error display			Error code	Description
OPERATION lamp (green)	TIMER lamp (orange)	ECONOMY lamp (green)		
●(6)	●(2)	◇	62	Outdoor unit main PCB model information error or communication error
●(6)	●(3)	◇	63	Inverter error
●(6)	●(4)	◇	64	Active filter error, PFC circuit error
●(6)	●(5)	◇	65	Trip terminal L error
●(6)	●(8)	◇	68	Outdoor unit rush current limiting resistor temp. rise error
●(6)	●(10)	◇	6A	Display PCB microcomputers communication error
●(7)	●(1)	◇	71	Discharge temp. sensor error
●(7)	●(2)	◇	72	Compressor temp. sensor error
●(7)	●(3)	◇	73	Outdoor unit Heat Ex. liquid temp. sensor error
●(7)	●(4)	◇	74	Outdoor temp. sensor error
●(7)	●(5)	◇	75	Suction Gas temp. sensor error
●(7)	●(6)	◇	76	• 2-way valve temp. sensor error • 3-way valve temp. sensor error
●(7)	●(7)	◇	77	Heat sink temp. sensor error
●(8)	●(2)	◇	82	• Sub-cool Heat Ex. gas inlet temp. sensor error • Sub-cool Heat Ex. gas outlet temp. sensor error
●(8)	●(3)	◇	83	Liquid pipe temp. sensor error
●(8)	●(4)	◇	84	Current sensor error
●(8)	●(6)	◇	86	• Discharge pressure sensor error • Suction pressure sensor error • High pressure switch error
●(9)	●(4)	◇	94	Trip detection
●(9)	●(5)	◇	95	Compressor rotor position detection error (permanent stop)
●(9)	●(7)	◇	97	Outdoor unit fan motor 1 error
●(9)	●(8)	◇	98	Outdoor unit fan motor 2 error
●(9)	●(9)	◇	99	4-way valve error
●(9)	●(10)	◇	9A	Coil (expansion valve) error
●(10)	●(1)	◇	A1	Discharge temp. error
●(10)	●(3)	◇	A3	Compressor temp. error
●(10)	●(4)	◇	A4	High pressure error
●(10)	●(5)	◇	A5	Low pressure error
●(13)	●(2)	◇	J2	Branch boxes error [Flexible multi-split type]

Display mode ● : 0.5s ON / 0.5s OFF  
◇ : 0.1s ON / 0.1s OFF  
( ) : Number of flashing